

# QST

May, 1933  
25 cents.

devoted entirely to

# amateur radio

*In this Issue—*

**New  
Equipment  
for the  
Ultra-Short-  
Waves**

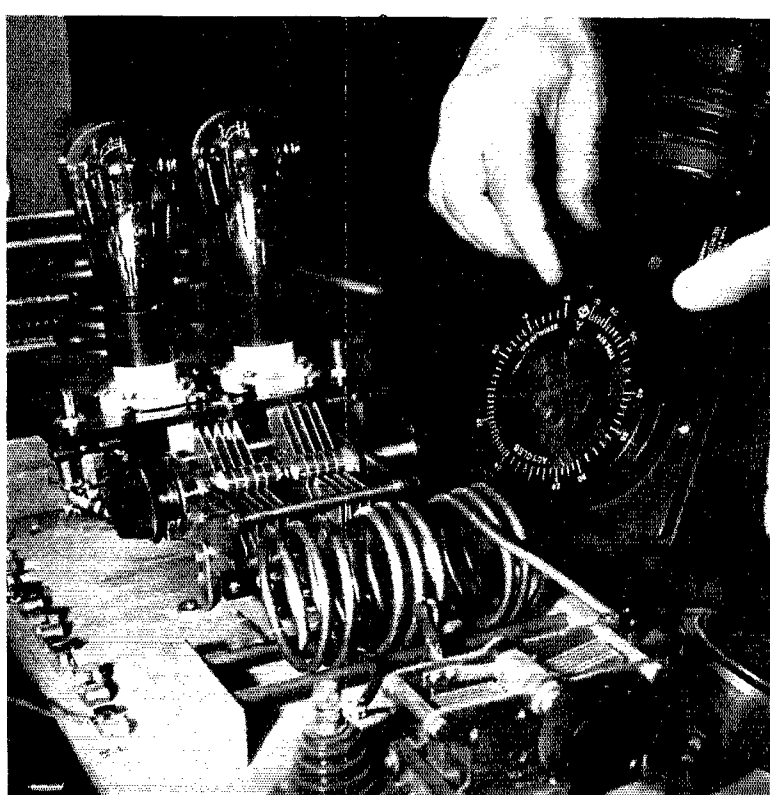

# OPERATING

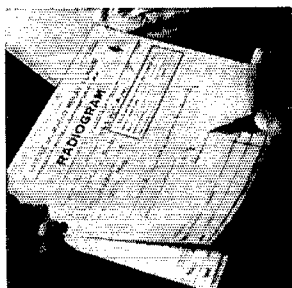

**Message Blanks.** Most convenient form. Designed by the Communications Department of the A.R.R.L. Well printed on good bond paper. Size  $8\frac{1}{2} \times 7\frac{1}{4}$ . Put up in pads of 100 sheets. One pad postpaid for 35c or 3 pads for \$1.00.

**Log Books.** Bound with heavy paper covers.  $8\frac{1}{2} \times 10\frac{3}{4}$ . Contains 39 log pages, like below, and 39 blank pages for miscellaneous notes. Also list of Q sigs, message number sheet and sheet of cross-section paper. 40c each or 3 for \$1.00. Postpaid.

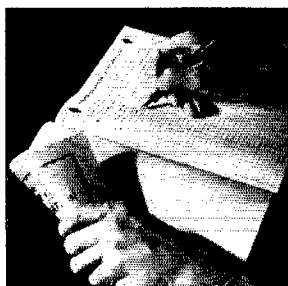

# M A T T E R I A L



**A.R.R.L. Letterheads.** Write your radio letters on League stationery — it identifies you. Lithographed on  $8\frac{1}{2} \times 11$  heavy bond paper. Postpaid. 100 sheets, 50c; 250 sheets, \$1.00; 500 sheets, \$1.75.

**Message Delivery Cards.** Neatest, simplest way to deliver a message to a near-by town. On U. S. stamped postals 2c each. On plain cards (for Canada, etc.) 1c each, postpaid.

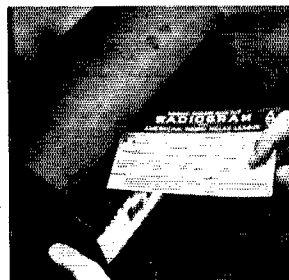

American  
Radio  
Relay  
League

# F O R M S

West  
Hartford  
Conn.  
U. S. A.

# GROSS "GC-30"

Series xtal controlled transmitters now available with Class B units and all power supplies in matched cabinets. This new equipment utilizes the new 59 tubes for maximum output at minimum cost. Commercial type apparatus fully enclosed in dust-proof, hinged cover cabinets. Installations can be placed as illustrated or along side of each other, since the R. F. stages are separate from the modulator unit and power supplies.

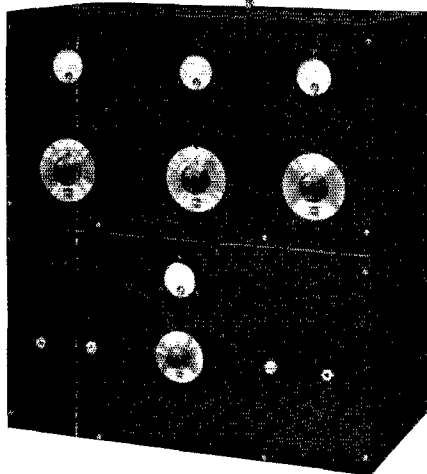

**GC-30 CW 30 watts output \$29.50**

'47 xtal oscillator — '10 buffer — '10 amplifier.

**GC-45 CW 45 watts output, \$37.50**

'47 xtal oscillator — '10 buffer — two '10's Push Pull amplifier.

**GC-100 CW 100 watts output \$39.50**

'47 xtal oscillator — '10 buffer — '03-A or '11 amplifier.

**PS-30 Power Supply \$29.50**

All plate and filament voltages for GC-30 or GC-45.

**PS-100 Power Supply \$39.50**

All plate and filament voltage for GC-100.

**GC-45-B Modulator and Power Unit \$52.00**

All plate and filament voltage for GC-30 or GC-45; also has incorporated in the same unit the Class B Modulator consisting of a '57-'59 and two '59's in Class B. This unit will give an audio output of 30 watts and will fully modulate a 40 watt carrier.

*Power supply and modulator units are all in cabinets to match the R.F. Stages. The above prices are all on assembled units ready to be wired, less tubes. Hoyt meters are supplied — if Weston meters are desired add \$3.50 for each meter.*

**WRITE FOR FULLY DESCRIPTIVE LITERATURE**

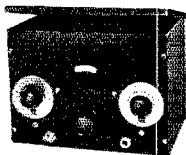

*"Eagle" Completely Wired and Tested* **\$10.95**

*Three Tubes Tested in Your Receiver* **\$3.50**

## The "EAGLE" Three Tube Short Wave Receiver

Only finest material used thruout — employs one '32 R. F., one '32 Detector and one '33 Pentode Audio — 15 to 200 meters — four coils supplied. The "Eagle" is economical — two dry cells will operate the filaments.

See March or April QST for full description on this most excellent value in short wave receivers.

**25 WARREN STREET**  
N. Y. C. TELEPHONE BARCLAY 7-6698



*20% deposit with all C. O. D. orders.*  
*For prompt shipment remit by*  
*M. O. Include Postage.*

Now... *Hygrade Sylvania* Announces

# A Complete Electronics Department

■ full production facilities ■ leading electronics engineers

**F**OR more than 30 years, the Hygrade Sylvania Corporation, and its predecessors have supplied the electric light industry with standard lamps of highest quality and uniformity. And since earliest days of radio, this company has pioneered in the development of radio tubes.

Now, with the formation of its new Electronics Department, the Hygrade Sylvania Corporation expands to meet the newer demands of electronics. In addition to lamp bulbs and radio set tubes, this company now produces radio transmitters, transmitter tubes, special receivers, industrial tubes and custom-built electronic devices of every specialized nature.

A technical staff composed of William J. Barkley, General Manager; D. F. Replogle, Chief Engineer; Victor O. Allen, Assistant Chief Engineer; and 22 other electronics engineers and executives, all formerly associated with the DeForest Radio Company; a complete research laboratory fully equipped for any purpose required in the electronic art; and ample production facilities insured by a new fully equipped plant where all electronics work will be coordinated—all of these factors add to the Hygrade Sylvania resources the same skill and knowledge responsible for today's most important commercial applications of electronics.

The Hygrade Sylvania Corporation invites you to avail yourself of its technical experience, and vast production and research facilities. For consultations, write to:



**THE HYGRADE SYLVANIA CORPORATION**

Electronics Division

**64 Lakeview Avenue**

**Clifton, New Jersey**

© 1933, T. H. S. C.

# QST

Published monthly, as its official organ, by the American Radio Relay League, Inc., at West Hartford, Conn., U. S. A.; Official Organ of the International Amateur Radio Union

devoted entirely to

# AMATEUR RADIO

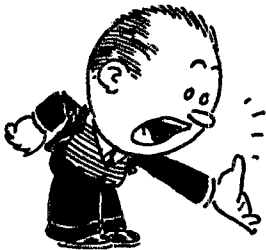

|  |    |
|--|----|
| Editorials   | 7  |
| Southern California Amateurs Rise to Earthquake Emergency  | 9  |
| <i>Clinton B. DeSoto</i>   |    |
| The Modulation Monitor   | 11 |
| Roanoke Division Convention (Announcement)   | 11 |
| Getting Quality Performance With Class B Modulation  | 12 |
| <i>Arthur A. Collins, W9CXX</i>  |    |
| Let's Crack the 28-Mc. Nut   | 18 |
| Improving the Sensitivity of the S. S. "Five" Receiver   | 19 |
| A Sensitive Tuning Indicator   | 20 |
| <i>J. D. Blitch, W4IS</i>  |    |
| Graduating to Oscillator-Amplifier Transmitters on 56-Mc.  | 21 |
| <i>D. A. Griffin, W2AOE</i>  |    |
| Improving the 56-Mc. Receiver  | 23 |
| <i>Calvin F. Hadlock, W1FFR</i>  |    |
| Erecting a 90-Foot Mast With a Tire Jack   | 27 |
| <i>E. W. Lincoln, W1BNM</i>  |    |
| New Tube Designations  | 28 |
| Hudson Division Convention (Announcement)  | 28 |
| Was This "The Old Man"?  | 29 |
| <i>As told to R. B. Bourne, W1ANA</i>  |    |
| Still More Tubes   | 30 |
| For the Experimenter   |    |
| LINK COUPLING — MINIMIZING FREQUENCY DRIFT — FEED-BACK PREVENTION — A PINCH-HITTING NEUTRALIZING STUNT — A HINT FOR REDUCING NOISE LEVEL — REVAMPING THE OLD MAJESTIC "B" SUPPLY | 31 |
| Silent Keys  | 33 |
| Checking the Performance of the Superheterodyne First Detector   | 34 |
| <i>Alfred L. Chaney, W6AIA</i>   |    |
| Strays   | 36 |
| Amateur Radio Stations   | 37 |
| <i>W8AFM, W8CMA, W6ADK</i>   |    |
| Communications Department  | 39 |
| I. A. R. U. News   | 55 |
| Calls Heard  | 57 |
| Correspondence Department  | 58 |
| Book Reviews   | 66 |
| Standard Frequency Transmissions   | 72 |
| Help Us — and Help Yourself  | 74 |
| Hamads and QRAs  | 75 |
| QST's Index of Advertisers   | 78 |

MAY  
1933

VOLUME XVII  
NUMBER 5

Kenneth B. Warner (Secretary, A.R.R.L.), *Editor-in-Chief and Business Manager*; Ross A. Hull, *Associate Editor*; James J. Lamb, *Technical Editor*; George Grammer, *Assistant Technical Editor*; Clark C. Rodimon, *Managing Editor*; David H. Houghton, *Circulation Manager*; F. Cheyney Beckley, *Advertising Manager*; Ursula M. Chamberlain, *Assistant Advertising Manager*.

*Editorial and Advertising Offices*  
38 La Salle Road, West Hartford, Conn.

Subscription rate in United States and Possessions and Canada, \$2.50 per year, postpaid; all other countries, \$3.00 per year, postpaid. Single copies, 25 cents. Foreign remittances should be by international postal or express money order or bank draft negotiable in the U. S. and for an equivalent amount in U. S. funds.

Entered as second-class matter May 29, 1919, at the post office at Hartford, Connecticut, under the Act of March 3, 1879. Acceptance for mailing at special rate of postage provided for in section 1103, Act of October 3, 1917, authorized September 9, 1922. Additional entry at Concord, N. H., authorized February 21, 1929, under the Act of February 23, 1925.

Copyright 1933 by the American Radio Relay League, Inc.  
Title registered at United States Patent Office.

# A FEW COMET "PRO" USERS

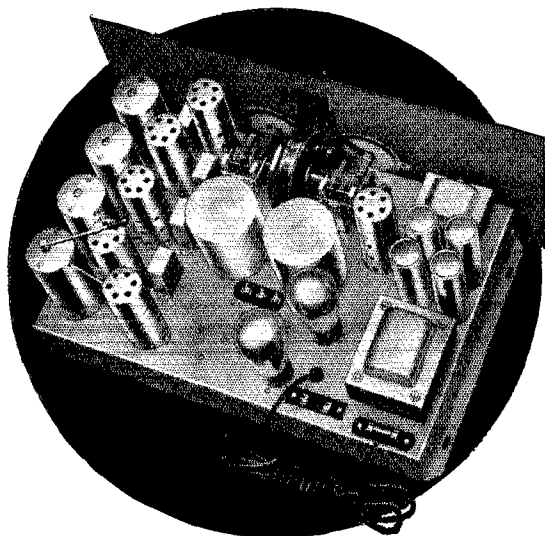

Several of the users, listed below, operate more than fifty COMET "PRO" Short-Wave Superheterodynes — some operate more than one hundred.

Picture in your mind the exacting performance which such organizations require. You will then realize what a delight it would be to you to own this superb receiver, built to professional standards.

## MAIL COUPON FOR DETAILS

### AIRWAYS

American Airways  
Eastern Air Transport  
Northwest Airways  
Transcontinental & Western Air, Inc.  
Inter-American Aero Travel and Supplies  
44th Division Aviation, N. J.  
War Department, Air Corp., Wright Field

### BROADCAST SYSTEMS

Columbia Broadcasting System  
Station WOR  
Station WOWO  
Station WAIU  
Station WINS  
Station WCAO  
Icelandic State Broadcasting Service, Reykjarik, Iceland  
Short Wave Station VE9GW, Canada  
Station CMKA, Cuba

### NEWS SERVICE

American Radio News Service  
U. S. Embassy, Santiago, Chile  
Argentine Embassy, Paris, France

### DOMESTIC COMMERCIAL SERVICE

Georgia Agricultural Dept.  
Police Dept., Youngstown, O.  
Police Dept., Klamath Falls, Ore.  
Albany Junior Chamber of Commerce  
Mississippi State Penitentiary  
Hotel New Yorker

### FOREIGN COMMERCIAL SERVICE

Radio Electric, Switzerland  
Technish Bureau, Kolomen, Holland  
Prometheus, Greece  
Rothermel Corp., Belgium  
Eltone Ceritte, Italy  
Muvaffak Bey, Ankara, Turkey  
Standard Oil Co. of Venezuela  
Harry Pegram, South Africa  
W. F. Greene, Dutch West Indies  
Pedro Perez, Saintz, Spain  
Post Exchange, Canal Zone

### WAR DEPARTMENT

Message Center, Washington  
Headquarters, 8th Corp Area,  
Fort Sam Houston

Signal Section, San Francisco  
Signal Section, Honolulu, T. H.  
Signal Section, Manila, P. I.  
Signal Section, Corozal, C. Z.  
Headquarters, 4th Corp Area,  
Fort McPherson  
Headquarters, 9th Corp Area

### NAVY DEPARTMENT

Naval Research Labs., Washington  
U. S. S. Woodcock  
Radio Material School, Washington  
9th Naval District  
U. S. Navy Yard, Charleston, S. C.  
Marine Corp, Signal Section

### FOREIGN GOVERNMENT SERVICE

Department of National Defense, Canada  
Director of Signals, Canada  
Director of Naval Stores  
Royal Administration of Telegraph, Stockholm  
Radio Nautica, Italy  
First Brigade Exchange, Haiti

## PROMINENT AMATEURS IN ALL DISTRICTS

HAMMARLUND MANUFACTURING CO.  
424 W. 33rd St., New York

Check here for General Catalog.  Check here for folder on new Air-Tuned I.F. Transformers.  Check here for new booklet describing the COMET "PRO" in detail.

Name.....

Address.....

.....Q-5



# Section Communications Managers of THE COMMUNICATIONS DEPARTMENT, A. R. R. L.

|   |   |  |   |   |
|---|---|--|---|---|
| Eastern Pennsylvania<br>Maryland-Delaware-District<br>of Columbia<br>Southern New Jersey<br>Western New York<br>Western Pennsylvania                                  | W3GS<br>W3NY<br>W3QL<br>W8DSP<br>W8CUG  | <b>ATLANTIC DIVISION</b><br>Jack Wagenseller<br><br>Harry Ginsberg<br>Gedney Rigor<br>Don Farrell<br>C. H. Grossarth   | 210 Main St.<br><br>2305 N. Pulaski St.<br>412 2nd Ave.<br>213 Hickok Ave.<br>R. F. D. 3, Eicher Rd.  | Pennsburg<br><br>Baltimore, Md.<br>Haddon Heights<br>Syracuse<br>Emsworth, Bellevue,<br>Pa.   |
| Illinois<br>Indiana<br>Kentucky<br>Michigan<br>Ohio<br>Wisconsin  | W9WR<br>W9TE<br>W9OX<br>W8DYH<br>W8BAH<br>W9FSH   | <b>CENTRAL DIVISION</b><br>Fred J. Hinds<br>Arthur L. Braun<br>Carl L. Plumm<br>Kenneth F. Conroy<br>Harry A. Tummonds<br>Harold H. Kurth  | 6618 West 34th St.<br>1521 Spruce St.<br>P. O. Box 339<br>7553 E. Robinwood Ave.<br>2073 West 85th St.<br>2550 N. 8th St.   | Berwyn<br>Indianapolis<br>Louisville<br>Detroit<br>Cleveland<br>Milwaukee   |
| North Dakota<br>South Dakota<br>Northern Minnesota<br>Southern Minnesota  | W9DGS-IFW<br>W9DKL<br>W9DOQ<br>W9EPJ  | <b>DAKOTA DIVISION</b><br>Wm. Langer<br>C. B. Miller<br>Palmer Andersen<br>Norman Beck   | 313 First Ave., S.<br>449 N. 5th St.<br>Route 1, Box 270<br>415 Grand St.   | Jamestown<br>Redfield<br>Duluth<br>Winona   |
| Arkansas<br>Louisiana<br>Mississippi<br>Tennessee   | W5ABI<br>W5WF<br>W5AZV<br>W4AFM   | <b>DELTA DIVISION</b><br>H. E. Velte<br>W. J. Wilkinson, Jr.<br>William G. Bodker<br>F. F. Purdy   | 2918 West 15th St.<br>1624 Allen Ave.<br>1013 Bratton St.<br>P. O. Box 173  | Little Rock<br>Shreveport<br>Jackson<br>Jacksport   |
| Eastern New York<br>N. Y. C. & Long Island*<br>Northern New Jersey  | W2LU<br>W2AZV<br>W2CO   | <b>HUDSON DIVISION</b><br>Robert E. Haight<br>E. L. Baunach<br>Walter A. Cobb  | 1080 Helderberg Ave.<br>7823 10th Ave.<br>28 Ampere Parkway   | Schenectady<br>Brooklyn<br>East Orange  |
| Iowa<br>Kansas<br>Missouri<br>Nebraska  | W9FFD<br>W9FLG<br>W9EYG-HCP<br>W9FAM  | <b>MIDWEST DIVISION</b><br>George D. Hansen<br>C. J. Spetzer<br>C. R. Cannady<br>Samuel C. Wallace   | Box 27<br>305 Western Ave.<br>210 W. McCarty<br>Green St.   | Salix<br>Topeka<br>Jefferson City<br>Clarks   |
| Connecticut<br>Maine<br>Eastern Massachusetts<br>Western Massachusetts<br>New Hampshire<br>Rhode Island<br>Vermont  | W1CTT<br>W1CDX<br>W1ASI<br>W1ASY-W1RB<br>W1ATJ<br>W1AWE<br>W1BD                                     | <b>NEW ENGLAND DIVISION</b><br>Frederick Ellis, Jr.<br>John W. Singleton<br>Joseph A. Mullen<br>Earl G. Hewinson<br>V. W. Hodge<br>N. H. Miller<br>Roy Gale  | 19 Merrill Rd.<br><br>16 Mercier St.<br>33 Cortland St<br>8 Sullivan St.<br>25 Phillips St.<br>41 Beacon St.  | Norwalk<br>Wilton<br>Ashmont<br>Springfield<br>Claremont<br>Providence<br>Barre   |
| Alaska<br>Idaho<br>Montana<br>Oregon<br>Washington  | K7PQ<br>W7AYH<br>W7AAT-7QT<br>W7ABZ<br>W7RT   | <b>NORTHWESTERN DIVISION</b><br>Richard J. Fox<br>Charles K. Thrapp<br>O. W. Viers<br>Raymond L. Cummins<br>John P. Gruble   | Box 301<br>1011 East Jefferson St.<br><br>4835 N. Amherst St.<br>1921 Atlantic St.  | Ketchikan<br>Boise<br>Red Lodge<br>Portland<br>Seattle  |
| Hawaii<br>Nevada<br>Los Angeles<br>Santa Clara Valley<br>East Bay<br>San Francisco<br>Sacramento Valley<br>Arizona<br>Philippines*<br>San Diego<br>San Joaquin Valley | K6COG<br>W6EAL<br>W6AAN<br>W6AMM<br>W6ZM<br>W6CAL<br>W6DVE<br>W6BJF-W6QC<br>KALXA<br>W6EOP<br>W6DZN | <b>PACIFIC DIVISION</b><br>C. D. Slaten<br>Keston L. Ramsay<br>Francis C. Martin<br>Bruce Stone<br>S. C. Houston<br>Byron Goodman<br>Geo. L. Woodington<br>Edward Mendoza<br>Newton E. Thompson<br>Harry A. Ambler<br>G. H. Lavender | Pearl City<br>1151 Buena Vista Ave.<br>738 W. Huntington Drive<br>R. 1, Box 311<br>2523 23rd Ave.<br>141 Alton Ave.<br>716 Redwood Ave.<br>1434 East Madison St.<br>714 Tennessee<br>4101 Hamilton St.<br>R. 6, Box 425 | Oahu<br>Reno<br>Arcadia<br>San Jose<br>Oakland<br>San Francisco<br>North Sacramento<br>Phoenix<br>Mantoloking, P. I.<br>San Diego<br>Stockton |
| North Carolina<br>Virginia<br>West Virginia   | W4DW<br>W3AAJ<br>W8HD   | <b>ROANOKE DIVISION</b><br>H. L. Caviness<br>R. N. Eubank<br>C. S. Hoffmann, Jr.   | 2303 Clark Ave.<br>2817 Montrose Ave.<br>126 Washington Ave.  | Raleigh<br>Richmond<br>Wheeling   |
| Colorado<br>Utah-Wyoming  | W9BTO<br>W6DPJ  | <b>ROCKY MOUNTAIN DIVISION</b><br>T. R. Becker<br>C. R. Miller   | 1176 Gaylord St.<br>134 E. 2nd North St.  | Denver<br>Provo, Utah   |
| Alabama<br>Eastern Florida<br>Western Florida<br>Georgia-S. Carolina-Cuba-<br>Isle-of-Pines-Porto Rico-<br>Virgin Islands   | W4KP<br>W4NN<br>W4MS<br><br>W4PM  | <b>SOUTHEASTERN DIVISION</b><br>L. B. Elwell<br>Ray Atkinson<br>Edward J. Collins<br><br>Chas. W. Davis  | 1066 Waverly St.<br>329 East First St.<br>1517 East Brainard St.<br><br>668 Cooledge Ave., N.E.   | Tarrant<br>Jacksonville<br>Pensacola<br><br>Atlanta   |
| Northern Texas<br>Oklahoma<br>Southern Texas<br>New Mexico  | W5RJ<br>W5VQ<br>W5BHO<br>W5AUW  | <b>WEST GULF DIVISION</b><br>Roy Lee Taylor<br>Eliel Gisel<br>David H. Calk<br>Jerry Quinn   | 1614 St. Louis Ave.<br>151 Ballou Co.<br>6726 Ave. Q<br>518 W. Marquette Ave.   | Ft. Worth<br>Bartlesville<br>Houston<br>Albuquerque   |
| Maritime  | VE1DQ   | <b>MARITIME DIVISION</b><br>A. M. Crowell  | 69 Dublin St.   | Halifax, N. S.  |
| Ontario   | VE3HB   | <b>ONTARIO DIVISION</b><br>H. W. Bishop  | 258 Egerton St.   | London  |
| Quebec*   | VE2AP   | <b>QUEBEC DIVISION</b><br>J. C. Stadler  | 4334 Westmount Ave.   | Westmount, P. Q.  |
| Alberta<br>British Columbia   | VE4HM<br>VE5AL  | <b>VANALTA DIVISION</b><br>C. H. Harris<br>J. K. Cavalsky  | 10806 125th St.<br>4868 Blenheim St.  | Edmonton<br>Vancouver   |
| Manitoba<br>Saskatchewan  | VE4GC<br>VE4EL  | <b>PRAIRIE DIVISION</b><br>Reg. Strong<br>Wilfred Skaife   | 284 Marion St.<br>2040 McTavish St.   | Winnipeg<br>Regina  |

\* Officials appointed to act until the membership of the Section choose permanent SCM's by nomination and election.

# The American Radio Relay League



## THE AMERICAN RADIO

RELAY LEAGUE, INC., is a non-commercial association of radio amateurs, bonded for the promotion of interest in amateur radio communication and experimentation, for the relaying of messages by radio, for the advancement of the radio art and of the public welfare, for the representation of the radio amateur in legislative matters, and for the maintenance of fraternalism and a high standard of conduct.

It is an incorporated association without capital stock, chartered under the laws of Connecticut. Its affairs are governed by a Board of Directors, elected every two years by the general membership. The officers are elected or appointed by the Directors. The League is non-commercial and no one commercially engaged in the manufacture, sale or rental of radio apparatus is eligible to membership on its board.

"Of, by and for the amateur," it numbers within its ranks practically every worth-while amateur in the world and has a history of glorious achievement as the standard-bearer in amateur affairs.

Inquiries regarding membership are solicited. A bona fide interest in amateur radio is the only essential qualification; ownership of a transmitting station and knowledge of the code are not prerequisite. Correspondence should be addressed to the Secretary.

A directory of the amateur societies affiliated with the League, showing their times and places of meetings, is available upon request.

## DIRECTORS

- President*  
HIRAM PERCY MAXIM.....W1AW  
Box 216, Hartford, Conn.
- Vice-President*  
CHARLES H. STEWART.....W3ZS  
St. David's, Pa.
- Canadian General Manager*  
ALEX. REID.....VE2BE  
169 Logan Ave., St. Lambert, P. Q.
- Atlantic Division*  
EUGENE C. WOODRUFF.....W8CMP  
234 W. Fairmount Ave., State College, Pa.
- Central Division*  
LOREN G. WINDOM.....W8GZ-W8ZG  
1375 Franklin Ave., Columbus, Ohio
- Dakota Division*  
LAWRENCE E. LINDESMITH.....W9GKO  
1055-85th Ave. W., Duluth, Minn.
- Delta Division*  
M. M. HILL.....W5EB  
P.O. Box 274, Natchitoches, La.
- Hudson Division*  
BERNARD J. FULD.....W2BEG  
280 Broadway, New York City
- Midwest Division*  
H. W. KERR.....W9DZW-W9GP  
Little Sioux, Iowa
- New England Division*  
G. W. BAILEY.....W1KH  
74 Webster Road, Weston, Mass.
- Northwestern Division*  
RALPH J. GIBBONS.....W7KV-W7BIX  
35 Park St., Walla Walla, Wash.
- Pacific Division*  
S. G. CULVER.....W6AN  
2303 Seventh Ave., Oakland, Calif.
- Roanoke Division*  
H. L. CAVENESS.....W4DW  
State College Station, Raleigh, N. C.
- Rocky Mountain Division*  
RUSSELL T. ANDREWS.....W9AAB  
169 So. Ogden St., Denver, Colo.
- Southeastern Division*  
J. C. HAGLER, JR.....W4SS  
2424 McDowell St., Augusta, Ga.
- West Gulf Division*  
FRANK M. CORLETT.....W5ZC  
2515 Catherine St., Dallas, Tex.

## OFFICERS

- President*.....HIRAM PERCY MAXIM, W1AW  
Hartford, Connecticut
- Vice-President*.....CHARLES H. STEWART, W3ZS  
St. David's, Pennsylvania
- Secretary*.....KENNETH B. WARNER, W1EH  
West Hartford, Connecticut
- Treasurer*.....ARTHUR A. HEBERT, W1ES  
West Hartford, Connecticut
- Communications Mgr.*, F. EDWARD HANDY, W1BDI  
West Hartford, Connecticut
- General Counsel*.....PAUL M. SEGAL, W3EEA  
1010 Shoreham Building, Washington, D. C.

Address all general correspondence to the executive headquarters at West Hartford, Connecticut





# THE EDITOR'S MILL

**T**RUE to the finest traditions of amateur radio was the service of the amateurs of our Los Angeles Section when the recent disastrous earthquake occurred in their area. When everyone else rushed outdoors for relative safety, they manned their stations and commenced those several days of emergency communication work that received the plaudits of the Federal Radio Commission, the press, and citizens generally. Since the Los Angeles Section has frequently led the nation in traffic activity, it is not surprising that they were able to do an ace-high job.

Being no respecter of schedules, the quakes occurred right in our Fifth International Relay Competition, when many United States amateurs had vowed to work no W stations and everybody was keen for foreign DX. It was inspiring, the way the fellows all over the country ditched the contest to give a hand, and there is many a station whose contest record would have been much better but for the several days devoted to this emergency traffic — to say nothing of many local stations that closed down completely to eliminate interference. It was interesting, too, to see the very effective emergency communication established by 160-meter 'phone, an outstanding bit of 'phone work that is worth talking about.

All praise to all the amateurs who participated! You helped your fellow man and you showed anew what amateur radio can do.

**T**HAT fee bill has more lives than the proverbial cat. Since we last reported to our readers, the Senate fee bill was abandoned, a similar bill was introduced in the House, it in turn died with the demise of the last Congress, and now there is talk of the introduction of a similar bill in the new Congress. The last fee bill, which probably will be the pattern for any new one, took cognizance of A.R.R.L.'s demands on behalf of the amateur and eliminated all fees for everything except an initial \$1 for taking the operator examination. That is to say, if an amateur renews his license without letting it lapse, it would cost just one buck for all time. That is a considerable improvement over the first suggestion a year ago, which would have cost amateurs about \$3.50 a year, but we still say that that remaining \$1 is unnecessary and wrong in principle. We are keeping an eye on it.

**J**UST at this moment we are able to show a very swell occupancy of our 1715- to 2000-kilocycle band. To any extent that this is attributable to the current performance of the Kennelly-Heaviside Layer, so that our numbers might tend to diminish in the course of a few years with variation in transmission conditions, our ability to defend that band in subsequent international conferences is weakened. Strange as it may seem considering its restricted range, our toughest scrap at Madrid was about that band. It happens that right now the broadcasting folks of the world are raising a big rumpus to extend broadcasting downward in frequency at the expense of the mobile services. They go so far as to say that marine use of the 600- to 800-meter region is just the result of the accidental choice of those wavelengths in the first place, that there is no reason why they have to continue there, that the equipment for the most part is antiquated anyhow and will have to be replaced soon, and that these services might very well move immediately above 1500 kc. Of course the shipping people dispute this vigorously and firmly refuse to budge. But to the extent that broadcasting threatens the mobile services it threatens our bands, because the idea would be to put these very extensive services below 200 meters.

Far be it from us at Hq. to suggest to you fellows that you move into a new band for no other reason than to demonstrate occupancy and make a better showing four years from now. But it is worth pointing out that our lowest-frequency band is giving an excellent account of itself these days and that those who work there are getting splendid results in what we used to regard as a typical 3500-4000 manner but with less interference, and at the same time they have the satisfaction of knowing that they are helping amateur radio generally. Try it.

**W**HEN one ham writes to another who had an article in *QST*, asking him whether he can do this or that and get the same results or what size wire was it, or something of that sort, he ought to enclose return postage. It's common practice in the business world, even when the writer believes he is the only one making the inquiry. How much more ought this to be the case in amateur radio, where the recipient is not

in business for profit, has meagre facilities for correspondence, and yet receives inquiries by the score!

One amateur who had an article in *QST* recently told us that in 33 days he paid out of his own pocket \$9.30 for postage to mail letters of information back to inquirers! This particular amateur is out of work and can't possibly afford the money, but he didn't want to seem discourteous. Probably you never stop to think what your inquiries mean to the fellow on the other end, but if you think of this case you'll enclose a postage stamp next time.

For just the same reasons A.R.R.L. headquarters asks for postage with technical inquiries or requests for information on this and that. It is only 3¢ for the individual but it saves the League an awful lot in the course of a year. The League has felt the financial pinch and, with income reduced from general business conditions, has had to make many economies. Everybody at headquarters had a 10% salary cut more than a year ago, another 10% early this year, and the paid officers have taken an additional 5% on top of that. We haven't as much money for traveling as we used to have and there are a whole lot of things that it would be splendid to do but that we just can't afford for a while. So the return postage on letters of inquiry is going to be just as much appreciated by us as it is by *QST* authors.

**A**STHE current variation of the always-present had-note situation, we have on the air at present a mild epidemic of intentional tone-modulated telegraphy. It is *QST's* duty to point out that the deliberate application of modulation to telegraph signals is not permitted by the amateur regulations. To facilitate the development of the high frequencies through the employment of that most ingenious receiver, the super-regenerative, we have asked the Commission to authorize intentional tone-modulation in the case of our 28-mc. and 56-mc. bands. Other than that there should be none of it on the amateur ether. And when it comes down to such barbarous devices as choppers and buzzer interrupters — well, for our part we'd prefer a good old-fashioned spark gap in the antenna circuit. I.C.W. of the fashion produced by mechanically interrupting a radio-frequency circuit became obsolete, like spark, so long ago that the very mention of its prohibition disappeared from our regulations years ago!

Amateur telegraph signals are supposed to be pure d.c.c.w. except to the extent permitted by an "economy provision" in Section 382 of the Commission's regulations. It is there provided that power supplies must be either d.c. "or arrangements that produce equivalent effects to

minimize frequency modulation and prevent the emission of broad signals. For example, the use of unrectified alternating-current power supply for the amplifier stages of oscillator-amplifier transmitters, so arranged that variations in plate voltage of this supply cannot affect the frequency of the oscillator, will be considered satisfactory."

Let us explain what we mean by an economy provision. The Commission thought that all amateur power supply ought to be d.c. Some years ago, when these regulations were written, we pointed out that it would be a great hardship on the amateur who had a modern high-power station to oblige him to go to the expense of rectifiers and filters for a high-voltage high-power supply, and that in the case of crystal-controlled transmitters with buffer stages it was not exactly necessary to prohibit the use of alternating current for the power stage, since amplitude modulation in the form of side-bands would not be particularly objectionable. So it stands to-day, but its purpose is not to encourage modulated transmission; rather it is simply to permit existing methods to continue. (The League didn't think then that the time had come when we were all able to go to pure d.c. Perhaps we are now. How about it, gang?)

It is a far cry from this permission to the deliberate modulating of a signal to attract attention, as is now unfortunately being done by some amateurs. We have even heard of cases where a perfectly good d.c. signal was being wrecked by the application of modulation from a tone generator. This, we say, is wrong and selfish and contrary to regulations.

It's really very foolish, too. Everyone knows that the interference situation requires selective receivers. The more selective the receiver, the less effective a modulated signal. Most fellows realize that to-day our really selective receivers have firmly established the p.d.c. signal as the most effective. This is especially so with the Single-Signal receiver because it can tune so sharply as to ignore the energy in side bands. To give a little example, a transmitter with 1000-cycle 100% modulation wastes one-third of its power because only that in the carrier is utilized by the receiver.

It seems to us that any amateur who has a broad signal, whether it is a raspy gargle or what he calls "a beautiful bell-like note," stands convicted of wanton selfishness in these days. And the unnecessary tone-modulation even of an otherwise perfect signal ought to be recognized as just as great an offense against our common welfare — as it is also an offense against regulations and against modern theory.

K. B. W.

# Southern California Amateurs Rise to Earthquake Emergency

By Clinton B. DeSoto\*

**T**HE earth went mad, heaving itself in a giant, retching shudder. . . .

Ten minutes after the California earthquake an amateur station was on the air, telling the world.

Through the night, other amateurs emerged painfully from the wreckage, salvaged parts and tubes and power-supply facilities sufficient to get their stations back on the air again. Aid was offered the civic and military authorities in control of the situation; personal messages to relatives and friends of earthquake survivors commenced to trickle in; an avid press pleaded for information. The amateur emergency work of the Southern California earthquake on March 10th began in grim, actual earnest.

Six hours elapsed before any vestige of wire line service was through to Long Beach, center of the stricken area. It was four hours before broadcast station KFOX regained the air, the roof having fallen in the dynamo room. During this time amateur radio was the sole means of announcement and communication, and during the week following, when wire lines could not handle any appreciable percentage of the traffic, amateurs stepped to the fore as a communication system second to none in usefulness and efficiency.

The first official messages to be transmitted were from Mayor Harris of Long Beach and Mayor Porter of Los Angeles to the Adjutant-General of the state, requesting aid and reporting the loss of many lives. These were QST'ed by Francis M. Sarver, W6AOR, of Los Angeles, and by stations in the Long Beach and San Diego areas. A later message was addressed to Army officials at Washington, via W.A.R., requesting that the military at San Diego and surrounding points be instructed to operate in the

emergency zone. When they did take over control, Major Albert M. Jones, head of the intelligence department of the 9th Corps Area, invoked the aid of amateur radio in handling his branch of the work, with schedules between Long Beach and San Pedro.

A five-station net centering on W6GSR in Long Beach was for a considerable time the only means of communication with the Navy Yard at San Pedro, the National Guard headquarters there, and the governor's office and state motor patrol

officers at Sacramento. George F. Moynahan, Jr., W6AXT, was the Sacramento station, with C. N. Fisher, W6FFN, Covina, W6ETV, San Pedro, and Vernal Routh, W6CJQ, Los Angeles, as relay points. Messages were handled for Governor Rolph and Lt. Governor Frank Merriam. W6GSR was put out of commission by a severe shock at midnight, but was back on the air within an hour with a hastily rigged small portable set.

Al Martin, Jr., W6BYF, one of the first stations on the air in Long Beach after the first heavy tremors, handled official traffic exclusively from his installation at American Legion hall, where he was assisted by half a dozen operators. Great quantities of supplies, equipment and personnel were secured through this station.

KFOX, the Long Beach broadcasting station, which late in the evening began operating from an emergency booth in the Bail Bond office opposite City Hall, was overwhelmed with requests to broadcast messages reassuring relatives and friends of the safety of families and individuals, and turned this traffic over to amateur stations, as well as making announcements of the A.R.R.L. service. The bulk of the traffic received through this source was handled by W6BVD, assisted by W6BXI, W6UY, W6BQP and W6GXS. The biggest difficulty lay in the fact that the telephone at

## FEDERAL RADIO COMMISSION Washington, D. C.

March 18, 1933

The American Radio Relay League,  
38 LaSalle Road,  
West Hartford, Conn.

Attention: Mr. K. B. Warner

Dear Sir:

*The Commission takes pleasure in informing you that it has received information commending the amateurs of Southern California for the splendid work done by them in handling communications in the recent earthquake area.*

*The names of the individual licensees who cooperated in this work are not known to the Commission. However, it is known that amateurs have always rendered every possible assistance during times of such emergencies, and it is hardly necessary to add that the Commission believes such service to be of the highest order of importance.*

*It will be appreciated if you will express through the medium of the American Radio Relay League the Commission's appreciation of the prompt and efficient action which was taken by amateur licensees in bringing aid to the stricken area.*

Very truly yours,

/s/ HAROLD A. LAFOUNT,  
Acting Chairman.

\* WICBD, Assistant to the Secretary, A.R.R.L.

W6BVD was out of order along with hundreds of others, but after a conference with the manager of the telephone company an emergency line was rigged in less than an hour, and messages poured in along it in a steady stream.

In Los Angeles, where the damage was not nearly as great, nearly every active amateur in the city was to be found on watch. A big part of the relief traffic was with battleships lying off the California coast, whose officers and men had families ashore in the stricken cities. KFI, of Los Angeles, duplicated to some extent the work of KFOX in broadcasting information concerning the condition of individual families, but here again amateur radio service was considerably more effective.

The Los Angeles Police Department through municipal police radio station KGPL broadcast an urgent request for the erection of an amateur 'phone station at Los Angeles Patriotic Hall. Amateurs Nikirk, Cook and Strople of Pasadena responded and got W6BZC on the air, operating for 30 hours continuously. On the morning of March 13th, KFI broadcast a call for four amateur operators with portable receiving and transmitting equipment—and probably got them, although no further details are available.

Martin Corcoran, W6GOY, Artesia, W6GWX, South Pasadena, and stations in San Diego, Whittier, Santa Ana, San Clemente and La Jolla handled more than 500 messages for the American Red Cross, American Legion, Los Angeles General Hospital, Salvation Army, County Welfare

units and the California Highway Patrol. When W6GOY at Artesia announced, "Boy, that was quite a shake!" the operators at W6BZC, in Los Angeles, waited three seconds before feeling the tremor.

The 1.7- and 4-mc. 'phone men did Herculean work, handling traffic to all sections of the country and broadcasting general information. The 1.7-mc. men, particularly, were the best organized of those active in any band during the early part of the evening; all those in the earthquake area that had workable stations were on. QRM was a problem in the 75-meter band, but a group of stations including W6CNE, W6EZY, W8DLL, W9FLT, W8WI, W8AOE, W1CWH, W2GO, W2HY and W9MM helped to clear the band for the

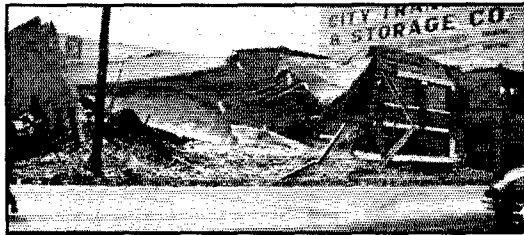

CHARACTERISTIC OF LONG BEACH'S DEMOLITION IS THIS VIEW OF RUINS NEAR WHERE AN AMATEUR EMERGENCY STATION WAS SET UP

emergency traffic.

One young schoolboy with a simple self-excited transmitter on 1750-kc. and a brand-new "H" license (we can't determine the rest of the call) hooked a microphone and loop around his tank coil and did some of the best of the early work for the authorities. In emergencies all methods are justified! Although his home and station were close to the beach and terrifying rumors of tidal waves were circulating, he didn't run out and hit for the hills, but stayed at his post. Many other amateurs with comparatively little experience did splendid work, proving that the race is to the willing, not to the swift, in times like these.

The number of stations actually contributing to amateur radio's public service record in this emergency reaches into the hundreds; there were dozens in the primary earthquake area alone. We mention, briefly, but with due regard for the importance of their work, the following: W. A. Adams, W6ANN, Long Beach, who handled hundreds of personal messages, delivering much of his traffic direct on 14 mc. Vernon Keays, W6GRH, Huntington Park, who was on the air by 8:05 p.m. and handled traffic until 10 a.m., hanging onto receiver and transmitter with both hands in involuntary QSK during shocks—as did most of the other stations in the area; WLVR, WLVG, WLVE—both the Army and Navy nets displayed wonderful organization; Ludwig A. Hedstrom, W6CIZ, Oakland; who kept continuous watch on 7 mc. for three days, along with A. W. Fuller, W6AF, Oakland; Ed. Stevens, W7BB, Seattle, who took 1500 words of press to an AP direct wire and handled 300 messages in 48 hours' continuous watch. W6CIU, W6HBF, W6FQY, W6FDE, W6LN, W6FYN, W6CMT,



EMERGENCY TRAFFIC FLOWED WITHOUT PAUSE FROM THE KEY AT W6BVD

Edward Secley, W6GXS, is shown at the operating position, while M. J. Campbell, W6UY, takes down messages from earthquake survivors via the emergency telephone line.

W6BTZ, W6EGJ, W6FWJ, W6AEP, W6EPW, W6AXQ, W6FEP, W6CJQ, W6HFP, W6MK, W6DEP and W6AM all deserve praise for splendid work, which we unfortunately do not have space to recount, even had we the details. Nor does this exhaust the list of active stations; it merely includes those concerning whose activities we have received reports. The calls of many other participating stations will be found in the Communications Department sectional reports this issue.

Dwight B. Williams, W6RO, transmitted a graphic "running" description of the 'quake to Ed. Stevens, W7BB, which was used verbatim by the *Seattle Daily Times*. The *Boston Post* got much the same story from Williams through George W. Bailey, W1KH, who stayed with him until a major shock forced W6RO off the air.

Forrest P. Wallace, W9CRT, announcer at WMAQ in Chicago, LeRoy Moffett, W9IJ, engineer at WENR, Chicago, and B. G. Swift of NBC's Chicago musical department, with the aid of W9VS of Oak Park, furnished all news of the earthquake that was broadcast over the NBC network, from the reports sent by amateurs in the area. Route Manager Wallace appealed to amateurs over the network to refrain from using their transmitters unless in actual contact with the coast — a new method of amateur control. It was Wallace who, after a QSO with a Los Angeles station the Sunday following the disaster, reported the ardent Californian as ending his description of the 'quake with the words, "But the climate is still fine. Come on out . . . !"

Evidence of the prestige of amateur radio in time of emergency is the experience of Edward D. Seeley, W6GXS, on his way from Los Angeles to Long Beach. He was halted not less than six times at police lines where sightseers were turned back, but each time, upon displaying his A.R.R.L. emblem and operator's ticket, he was permitted to pass.

Not only did amateurs handle thousands of messages of reassurance to relatives and friends from survivors, but in a number of instances they secured latest casualty lists from the stricken region and checked these lists for the names of individuals. Newspapers secured information on California visitors and relatives for entire cities in this way.

There is only one really dark spot on the record of public service in this emergency, and that is the attitude of one or two 4-mc. 'phone men in the

south and middle west, who were callously selfish in their refusal to stand by and cooperate, and the W6 who deliberately and boastfully QRMed some of the most important traffic handled by W6AOR. But on the other hand there was the excellent cooperative spirit displayed by many of the 7- and 14-mc. DX men who, while anxious to pile up good scores in the international tests, turned wholeheartedly instead to the relaying of the relief traffic which flooded the traffic lanes of the nation. Here's hoping their scores did not suffer too greatly as a result of their fine public-spiritedness.



W6EQW HAD TWO MESSAGES FOR PEOPLE HERE BUT HAD TO DELIVER THEM AT "MISSING PERSONS BUREAU"

The California earthquake was a marvelous opportunity for amateur radio, and the amateurs of Southern California and the rest of the country responded nobly. Their performance will clinch even more firmly in the mind of the nation the conviction that amateur radio is an essential and indispensable

asset to modern civilization.

(See Editorial, this issue. — Editor)

## Strays

### The Modulation Monitor

If the modulation monitor described in April *QST* is used with the bleeder resistor  $R_2$  connected as shown in the diagram on page 17, the milliammeter should be connected between the cathode and the top of the cathode resistor  $R_2$ . Otherwise the bleeder current, as well as the plate current of the tube, flows through the meter. It also has been found advisable to connect a fixed resistor of five-hundred thousand ohms in series with the adjustable  $R_2$ . Needless to say, the telephone jack should be insulated from the shielding to prevent shorting the "B" supply.

### Roanoke Division Convention

May 27th-28th, at West Virginian Hotel,  
Bluefield, W. Va.

The price of admission is \$2.50. Further information will be furnished by the Chairman of the Board, Bluefield Amateur Radio Club, Bluefield, W. Va., on request.

# Getting Quality Performance With Class B Modulation

Practical Design and Operating Data for Best Tube Combinations

By Arthur A. Collins, W9CXX\*

Here we present the long awaited practical information on Class B modulators using a variety of suitable tubes. The many who have requested data on 203-A's, 211's, and W.E. 242-A's will find the previously unavailable answers in this article. The no less valuable information on proper circuit conditions for distortionless operation will clear up a number of the misconceptions concerning Class B that seem to be prevalent.

—EDITOR.

CLASS B modulation met with instant approval in amateur circles. Since it was first presented in *QST*<sup>1</sup> some two years ago, thousands of amateur 'phones have changed over to Class B because its economy and the possibility of getting a lot of power out of little tubes appeal forcibly to the amateur.

With Class B operation you can get five to ten times the audio power output possible with Class A operation of the same tubes, and this greater output can be obtained with negligible distortion. But what is "negligible distortion"? The very cheapness of the system has led many conservatives to lift their eyebrows; "Perhaps it's all right for voice but not for music." Some light appeared

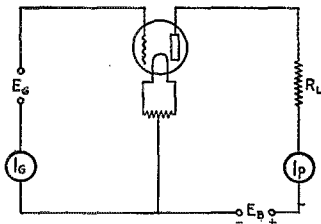

FIG. 1—CIRCUIT USED IN DETERMINING THE CHARACTERISTICS OF CLASS B OPERATION

to be thrown on the subject by certain published charts which plotted percent total harmonics against power output. But these charts apparently held for a single set of tubes, drivers and transformers. Slight circuit changes made big differences in results. The "voice-music" platitude apparently was going to be settled by the introduction of commercial models of broadcast receivers with Class B in the output stage. Certainly set engineers would not employ Class B if it was not OK. Listening to these new b.c. receivers usually leaves an uncertain impression as

to fidelity. Some of the best makes sound pretty good but others, especially the cheaper ones sound "hazy," "fuzzy" or "rattley" to the critical ear.

Neither does listening to Class B amateur 'phones lead to conclusive results. Some of them sound very good, others sound terrible. And then the offhand judgment of the human ear isn't very reliable anyway.

In this article I shall attempt to set down the results of development work extending over a considerable period of time and having to do with Class B amplification and Class B modulation. In this work the possibilities and limitations of this system have been quite carefully studied, and the different kinds of distortion peculiar to Class B have been analyzed and means found for overcoming them. Lest the word "distortion," used repeatedly in the following paragraphs, make the situation sound a little hopeless, it might be well to state at this point that it has been proved that Class B modulation is extremely well suited for use in high quality radio-telephone installations when the operating and circuit conditions are what they should be.

The general relations governing Class B circuits are well known, but are repeated briefly here for reference. The performance of any tube under ideal conditions can be studied by plotting its grid and plate current for different values of grid voltage and plate load (circuit of Fig. 1). The following equations hold:

$$\text{Power Output} = \frac{I_{pmax}^2 R_L}{2} \quad (1)$$

$$\text{Power Input} = 0.637 I_{pmax} E_b \quad (2)$$

$$\text{Plate Efficiency} = \frac{I_{pmax} R_L}{1.274 E_b} \quad (3)$$

Since the grid swings positive, it will draw current and consume power. The grid power is represented by the area under the grid curve. The grid impedance of most tubes is not linear and therefore the grids must be driven from a source

\* Collins Radio Company, Cedar Rapids, Iowa.

<sup>1</sup> Barton, "The Class B Push-Pull Modulator," Nov., 1931; Lamb and Grammer, "High-Power Performance From The Small 'Phone Transmitter," Dec. 1931, *QST*.

having good regulation. This fact has been mentioned repeatedly, but many amplifier designers seem to have overlooked the strict requirements imposed by the grid circuit. To illustrate this point let us look at Fig. 2, the load curves for the familiar 46 tube.

#### DRIVER REQUIREMENTS

The grid curve is approximately a straight line out to about  $E_g = +40$ v. and its slope corresponds to an impedance of about 4000 ohms. However, the grid current increases rapidly as the grid swings past 40 volts, the exact slope of the curve depending on the plate load. The value of grid impedance at any point can be calculated by drawing a tangent to the curve at that point and measuring the slope.

$$R_g = \frac{\Delta e_g}{\Delta i_g}$$

When the grid swings to +50 volts, the grid impedance has dropped to about 900 ohms ( $R_L = 1450$  ohms). Now it is evident that the input voltage will be seriously distorted by the grid

load varying between 4000 ohms and 900 ohms unless precautions are taken so that the driver has very good regulation. Good regulation of the grid voltage can be obtained by using a power type Class A driver tube (or tubes) having low plate impedance, and by using an input transformer having as large a step-down ratio as is consistent with getting the required grid swing.

Table I gives operating data on eleven different tube setups for Class B modulation. Let us analyze the driver requirements of Setup No. 1, a single 46 Class A driving two 46's Class B. The Class A 46 has a plate impedance of 2400 ohms. It is coupled to the two Class B grids by a transformer with a turns ratio, total primary to  $\frac{1}{2}$  secondary, of 3 to 1. The peak voltage which can be developed across one-half the secondary is approximately equal to the driver plate volts divided by the turns ratio of the transformer. In this case 75 volts could be obtained whereas only 50 volts peak are required — a comfortable margin. Now the impedance across the primary of the transformer can be referred to the secondary by dividing it by the square of the turns

TABLE I

| Setup No.   | 1    | 2    | 3    | 4    | 5     | 6     | 7       | 8       | 9        | 10       | 11               |
|---|------|------|------|------|-------|-------|---------|---------|----------|----------|------------------|
| Class A Driver . . . . .  | 1-46 | 2-45 | 1-59 | 2-45 | 2-45  | 2-45  | 2-45    | 2-2A3   | 2-2A3    | 2-2A3    | 2-2A3            |
| Driver Plate Volts . . . . .  | 225  | 225  | 250  | 225  | 250   | 250   | 250     | 250     | 250      | 250      | 250              |
| Input Trans. Turns Ratio (Tot. Pri. vs. $\frac{1}{2}$ Sec.) . . . . . | 3:1  | 6:1  | 3:1  | 6:1  | 3.2:1 | 3.2:1 | 3.2:1   | 3.2:1   | 3.2:1    | 3.2:1    | 3.2:1            |
| Sec. Volts (Without Driver Distortion)                                | 75   | 75   | 83   | 75   | 157   | 157   | 157     | 157     | 157      | 157      | 157              |
| Neg. Bias Class B Tubes (Volts) . . . . .                             | 0    | 0    | 0    | 0    | -55   | -67   | -40     | -40     | -50      | -40      | -100             |
| Pos. Grid Swing (Volts) . . . . .                                     | 50   | 52   | 52   | 70   | 80    | 75    | 76      | 110     | 90       | 100      | 55               |
| Tot. Swing (Volts) . . . . .  | 50   | 52   | 52   | 70   | 135   | 142   | 116     | 150     | 140      | 140      | 155              |
| $R_L$ (Ohms) . . . . .  | 270  | 97   | 270  | 97   | 350   | 350   | 350     | 155     | 155      | 155      | 155              |
| Min. Grid Impedance (Ohms) . . . . .                                  | 900  | 650  | 800  | 300  | 1800  | 1800  | 1600    | 500     | 700      | 600      | 3000             |
| Min. Neg. Grid Impedance (Ohms) . . . . .                             | .... | .... | .... | .... | ....  | ....  | 2250    | 2400    | ....     | ....     | ....             |
| Class B Tubes (Two Tubes) . . . . .                                   | 46's | 46's | 59's | 59's | 10's  | 10's  | 203-A's | 203-A's | 203-A's* | 203-A's* | 242-A's or 211's |
| Plate Volts . . . . .   | 400  | 400  | 400  | 400  | 500   | 600   | 1000    | 1000    | 1000     | 1000     | 1000             |
| $R_L$ (Ohms Per Tube)**   | 1450 | 1750 | 1500 | 1500 | 2000  | 2000  | 2000    | 1250    | 2000     | 1450     | 2000             |
| $I_{pmax}$ (Ma.) . . . . .  | 170  | 170  | 170  | 195  | 170   | 240   | 350     | 520     | 425      | 575      | 316              |
| Average Plate Current (Ma.) . . . . .                                 | 108  | 108  | 108  | 134  | 108   | 153   | 223     | 330     | 270      | 366      | 200              |
| Max. Output* Watts (Distortion less than 5%) . . . . .                | 21   | 25   | 21   | 28   | 29    | 57.5  | 120     | 170     | 180      | 240      | 100              |
| Efficiency (Percent)  | 48.5 | 58   | 48.5 | 56.5 | 53.7  | 62.5  | 53.7    | 51.5    | 66.6     | 65.6     | 50               |
| Plate Dissipation Per Tube (Watts) . . . . .                          | 11.1 | 9.   | 11.1 | 10.5 | 12.5  | 17.25 | 50.2    | 80      | 45       | 63       | 50               |

\* Newest Type (Carbon Plate).

\*\* Multiply by 4 to get plate-to-plate load impedance for 2 tubes.

ratio;  $\frac{2400}{3^2} = 267$  ohms, which can be considered

as a resistance in series with a generator with perfect regulation. This series input resistance is referred to as  $R_i$  in the table and in Fig. 3.  $R_i$  should be small with respect to the minimum grid impedance if distortion of the grid voltage is to be avoided — about  $\frac{1}{2}$  to  $\frac{1}{6}$  the value of the latter, depending on the exact shape of the grid curve. Having found that we are driving the Class B

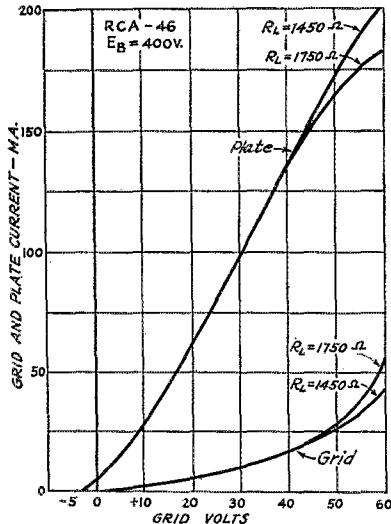

FIG. 2 — CLASS B CHARACTERISTICS FOR TWO 46'S

tubes satisfactorily, let us read on across the line and see what we are getting out of the setup. Fig. 2 shows that a peak grid voltage of +50v. gives a peak plate current ( $I_{p \max}$ ) of 170 ma. through a load resistance ( $R_L$ ) of 1450 ohms. The average plate current to the two tubes, as read on the plate milliammeter, is  $170 \times .637 = 108$  ma. Equations (1) and (2) give the output as 21 watts, the efficiency as 48.5 percent and the plate dissipation per tube as 11.1 watts. Experience has shown that calculated and observed outputs agree very closely when efficient transformers and power supplies of good regulation are used.

The illustration just given shows that Class B performance can be predicted quite easily — until you run into the "bugs." But before we consider the "bugs" and how to eliminate them, let us look down the list a little further and see what can be accomplished with different tube arrangements. Setup No. 2 is justified by lower ratio series resistance to grid impedance (over 6 to 1), greater output (25 watts), greater efficiency, and even less distortion, as compared to Setup No. 1. The next line and Fig. 3 show the performance of 59's driven by a single 59 Class A under most favorable conditions. There is little to choose

between the 59's and 46's in the same arrangement. But the output from 59's can be boosted to 28 watts by swinging their grids to +70 volts with push-pull 45's (Setup No. 4). Fig. 3 shows that excessive grid currents are drawn past  $E_g = 70$  volts, and it is not practicable to attempt much higher output from these tubes. In fact, the driving power required with multiple-grid zero-bias tubes becomes so large at about this point that it may not be advisable to design larger tubes of this type.

The next step in the direction of more power is the familiar 10, which was one of the first tubes suggested for Class B work. Setup No. 5 is the customary 10 arrangement with a plate voltage of 500, delivering 29 watts output. (Note that a 3.2:1 input transformer is used instead of the usual 2:1. Result: Vast improvement in quality.) Note also that 59's driven by 45's will deliver almost as much power, though they are cheaper tubes and require a less expensive power supply.

But by raising the plate voltage on the 10's to 600 volts (Setup No. 6) we can really get performance! Output is 57.5 watts with an efficiency of 62.5 percent. There is no increase in distortion if an adequate output transformer is used. Each tube dissipates 17.25 watts from its plate — which is 2.25 watts above rated value. However, this occurs only on loud passages and the average plate temperature will remain below normal. This is an excellent example of the way Class B output can be increased by raising the plate voltage so that allowable plate dissipation becomes the

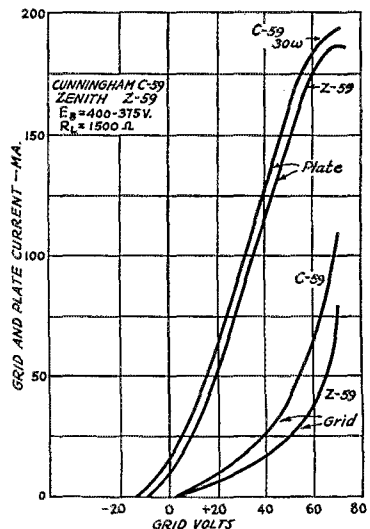

FIG. 3 — CLASS B CHARACTERISTICS OF TWO TYPES OF 59'S

limiting factor rather than filament emission. This expedient should *not* be tried on 46's and 59's because their complicated structure won't



stand the voltage. Plate load resistance usually should be increased with plate voltage and the whole idea must be handled with gloves in the absence of exact measuring equipment.

Setups 7 and 8 of Table I show the performance of 203-A's with p.p. 45's and p.p. 2A3's as drivers. The outputs shown are about the maximum obtainable from the type of 203-A's (or 503-A's) generally in use at the present time. Setups 9 and 10 indicate the marked improvement made in the very latest style of 203-A which is identifiable by its "carbon" (black) plate. The outputs are greater, efficiency is higher and the grids are easier to drive. These new tubes are also relatively free from secondary emission.

Setup 11 shows that 211's (or W.E. 242-A's) in Class B are good for 100 watts output but have the disadvantage of high bias requirements. However, the grid impedance is high so that they are easy to drive. Other low- $\mu$  tubes that can be used for Class B work are 45's, 2A3's, and 250's. All give good outputs in Class B or limited Class B ("A prime"). Type 845's are ruled out because of their large secondary emission from the grid. As a rule, the medium- or high- $\mu$  tubes are more convenient to handle.

#### TRANSIENT DISTORTION

Now for the "bugs" and "parasites." It is necessary to use transformers to couple the Class B tubes, to work in the familiar "push-pull" Class B circuit, and no transformer functions perfectly in its rôle of transferring a resistive load from primary to secondary. The leakage reactance and distributed capacity present in all transformers introduce certain complications in the circuit of Fig. 1, which must be taken into consideration in studying the performance of a Class B circuit. The equivalent network for a single Class B tube with transformer coupling to input and output circuits is shown in Fig. 4.

Refer first to the grid circuit.  $R_1$  is the input resistance introduced by reason of the plate impedance of the driver stage.  $L_1$  is the leakage reactance of the input transformer and  $C_1$  is its distributed capacity.  $R_{ac}$  represents the a.c. resistance of this circuit. In a similar way a resonant circuit appears in the plate circuit by virtue of the leakage reactance  $L_2$ , distributed capacity  $C_2$ , and a.c. resistance  $R_{ac}$  of the output transformer. Of course the input and output transformers each have a mutual inductance represented by  $L_3$  and  $L_4$ , respectively. This circuit bears some similarity to the familiar tuned-plate tuned-grid transmitter circuit and one might expect oscillations or other disturbances to be set up which would not be present in the basic circuit of Fig. 1. There is not sufficient coupling at audio frequencies through the tube capacities to cause oscillations in the ordinary fashion, but very distressing things can happen just the same.

Fig. 5 shows the plate, and grid curves for a

203-A tube of the older type. It will be noticed that, although the plate curve is straight over the greater part of its length, the grid curve represents a non-linear impedance and at one point the resistance is actually negative, as represented by a downward slope. The fact that the input resistance of the tube is not linear makes it necessary to employ a driver circuit having very good regulation. But this is not the entire difficulty. A circuit which has negative resistance is prone to oscillate in a "dynatronic" fashion. Thus the tank circuit which exists by reason of the leakage

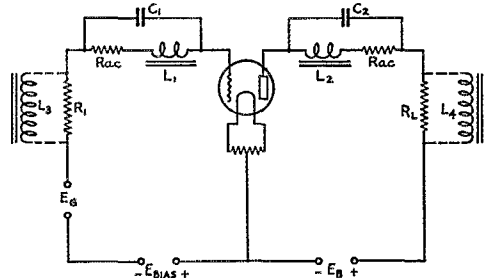

FIG. 4 — THE EQUIVALENT CIRCUIT OF A CLASS B STAGE WITH TRANSFORMER COUPLING

inductance and distributed capacity in each half of the input transformer secondary will tend to oscillate at its natural period when the grid swings through the portion of the curve where it has negative resistance. Oscillation will actually occur when the negative resistance is equal to, or less than, the shunt impedance of the tank circuit  $L_1 C_1 R_1$ . The values of  $L_1$  and  $C_1$  which are likely to occur in practice will give a resonant circuit having a fundamental frequency of from 4000 to 20,000 cycles. Thus these oscillations may occur within the upper range of audibility.

When this condition exists the oscillations can be very easily detected if the output of the Class B amplifier is connected to a cathode ray oscillograph. Over certain portions of the signal wave there will be small envelopes of high frequency oscillations which look very much like a drawing of a modulated radio frequency carrier. These transient oscillations do not persist over an appreciable part of the cycle because of the high damping which is usually present and because the grid exhibits negative resistance only during a short time in its positive swing.

Grid transients of this character are found only with certain tubes, including the 30, 112-A, 203-A and 849. The newer high- $\mu$  tubes, such as the 46's, 59's and 79's, which have been designed especially for Class B use, do not have a negative grid resistance at any point and they are relatively free from this difficulty. Transients occurring in the grid circuit have been observed on the cathode ray oscillograph with an amplitude almost as great as that of the signal frequency, and

of course this is a very serious condition. A Class B amplifier operating under this handicap will sound "fuzzy" or "indistinct." Since all transformers, no matter how carefully built, have a certain small value of leakage inductance and distributed capacity, it might appear to be quite difficult to eliminate the grid tank circuit which gives rise to these oscillations. However, the problem is not hopeless, and, in fact, the difficulty can be very easily corrected. When tubes which have

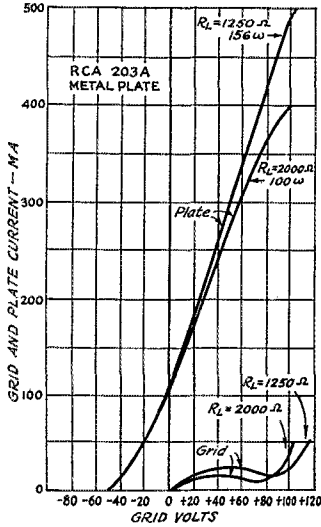

FIG. 5—THE GRID CHARACTERISTIC OF THE OLDER TYPE 203-A'S SHOWS NEGATIVE RESISTANCE

a "kink" in their grid characteristic are used, all that is necessary is to place a resistor between grid and filament which has a value approximately equal to the negative resistance of the grid circuit. A convenient value which serves for 203-A's, 211's, 204-A's and 849's is 5000 ohms. This resistance is considerably higher than the input series resistance  $R_1$  and causes very little additional loading on the driver stage.

Transients can also occur in the plate circuit of the tube independently of grid circuit transients. Plate transients will have a frequency in the upper audible or supraaudible regions, determined by the leakage reactance and distributed capacity of the output transformer ( $L_2 C_2$ ). Oscillations in this tank circuit may be excited over certain portions of the cycle by virtue of the fact that the plate current in each tube is not sinusoidal, but is approximately a half sine wave with slight irregularities caused by curvature both at the upper and lower ends of the plate characteristic. The plate impedance is, of course, never negative but oscillation can be started in an LCR circuit by switching on and off an a.c. wave. The ratio of oscillation amplitude to the signal amplitude depends upon the point at which the

current flow is started and stopped. Transients of this kind can be analyzed mathematically. Plate transients are usually less severe than grid transients unless an output transformer is used which has a high leakage inductance. Plate transients, of course, could be damped out in the same way as grid transients by connecting a resistor between the plate and "B"-plus. The amount of power lost in this resistor can be reduced by connecting a small capacity in series with it. If this expedient is necessary, serious attenuation of the high audio frequencies can be avoided by using a fairly large value of resistance and a small capacity which, nevertheless, will have a low reactance to the high-frequency transients. (A similar capacity-resistance load is sometimes placed between the plates of two Class B tubes, not only to avoid plate transients, but also to correct the frequency response of some types of loud speakers.)

In general it may be said that high-frequency transients can be one of the most serious causes of distortion in Class B systems. Their presence is sometimes overlooked because they will not show on a string oscillograph. They can be eliminated entirely, however, by the simple expedients outlined above.

#### INPUT TRANSFORMER DISTORTION

As explained before, the input transformer must have exactly the correct turns ratio. Many input transformers on the market have a lower step-down ratio than that indicated in Table I. A variation of 25 percent in the ratio will often cause an increase of 5 or 10 percent in the harmonics. But in addition to this requirement the input transformer must have very close coupling between primary and secondary; it must have low leakage inductance. High leakage inductance will introduce additional series input impedance at high frequencies and will aggravate tendencies toward transients. An efficient input transformer may employ inter-spaced or "pi" windings.

#### OUTPUT TRANSFORMER DISTORTION

Harmonic distortion is caused not alone by improper driving of a Class B stage but also by an inadequate output transformer. One of the most common deficiencies in output transformers is too low primary inductance. Suppose that the total primary inductance of an ordinary transformer is 12 henries under operating conditions. Each tube is connected across only half of the primary or across an inductance of 3 henries. Its reactance is in shunt with the load resistance and is equal to  $X_L = 2\pi fL$ . If a bass note of 80 cycles is sent through the system,  $X_L = 1500$  ohms. Without complicating this article by the use of vector quantities, it can be said that the tube at 80 cycles is working into a resistive load ( $R_L$ ) of 1450 ohms shunted by an inductance load of 1500 ohms, with

the result that the effective load is about one-half what it should be. The tube will, therefore, draw saturation plate currents, producing strong harmonics of the 80-cycle note. The higher frequency notes present at the same time will be distorted and the 80-cycle fundamental will be seriously attenuated. A Class B system handicapped in this way by a low inductance output transformer will sound "rough" and "grumbly" on bass passages. Poor bass response may be tolerated in equipment used exclusively for speech, since the lowest frequency common in male voices is about 120 cycles, but a bad output transformer can even garble speech to a certain extent. A transformer with too little inductance is much more serious in a Class B circuit than in a Class A circuit. In the latter it will only reduce the low frequency response, while in Class B it will also add annoying harmonics. It is impossible to compensate for low note attenuation in a Class B output transformer by accentuating the lows in preceding stages, since this will only increase the objectionable harmonics.

A good output transformer should have a primary inductance of not less than 20 henries, and it may run well over 30 henries if extreme bass response is required. The leakage inductance must be kept very low if plate transients and phase distortion are to be avoided. About 80 or 90 millihenries is an acceptable value of leakage inductance for each half of the primary. Leakage inductance, voltage ratio and distributed capacity must be the same for each half of the primary.

Primary inductance of the output transformer is tied in very closely with the questions of flux density and saturation due to d.c. in the secondary winding. Many output transformers have relatively small cores and, although the plate current to the modulated Class C stage may be carried through their secondary winding if fidelity is not important, a modulation choke and coupling condenser must be used if core saturation is to be prevented. Serious harmonic distortion can be introduced by working the core at high flux density, and it is usually desirable to use a very large core with an air gap even if the secondary is not to carry d.c. For this reason a Class B output transformer will usually be considerably larger than a power transformer of the

same rating. It is more economical and efficient to design a transformer capable of carrying the required d.c. through the secondary than it is to employ a smaller transformer with a modulation choke. The net cost of the transformer-choke-condenser arrangement will usually be greater than that of an adequate transformer. However, if a modulation choke is used it must have an actual inductance of 50 to 70 henries (instead of the customary 15 to 30 henries) if inductive loading of the Class B tubes is to be avoided.

#### DISTORTION DUE TO IMPROPER LOAD RESISTANCE

An examination of the curves for the various Class B tubes shows that small variations in load resistance cause a considerable shift in grid cur-

TABLE II

| Class C Tubes           | Class C Plate Volts | Class C Plate Ma. | $R_s$ Ohms | Suggested Modulation Setup (Table I) | Output Transformer Turns. Ratio $\frac{1}{2}$ Pri. to Secondary | Class B Plate Current for 100% Modulation M.A. | Approximate Carrier Output Watts* |
|-------------------------|---------------------|-------------------|------------|--------------------------------------|---|--|-----------------------------------|
| 2-46's                  | 400                 | 120               | 3300       | 1 or 3                               | 1 to 1.5  | 105  | 34                                |
| 1or2-10's               | 500                 | 100               | 5000       | 2                                    | 1 to 1.7  | 108  | 35                                |
| 2-10's                  | 500                 | 120               | 4170       | 4                                    | 1 to 1.66   | 124  | 42                                |
| 2-10's                  | 500                 | 120               | 4170       | 5                                    | 1 to 1.45   | 108  | 42                                |
| 1-03A or 11             | 750                 | 150               | 5000       | 6                                    | 1 to 1.58   | 153  | 80                                |
| 1-03A 11 or 242A        | 1000                | 200               | 5000       | 7, 9, or 11                          | 1 to 1.58   | 185-200  | 140                               |
| 2-03A's 11's or 242A's  | 1000                | 400               | 2500       | 10                                   | 1 to 1.31   | 335  | 280                               |
| 2-852's 860's or 1-204A | 2000                | 200               | 10,000     | 10                                   | 1 to 2.62   | 335  | 280                               |

\* Class C amplifier plate efficiency of 70%.

rents and plate saturation currents. For this reason it is imperative that the Class B stage be loaded properly. The values of  $R_L$  given in this article are for a single tube. The load impedance measured between the plates of the Class B tubes is four times the value given. The modulation impedance of a Class C stage is given by

$$R_s = \frac{\text{plate voltage Class C}}{\text{plate current Class C}}$$

Common values of modulation impedance are shown in Table II.

It is the function of the output transformer to  
(Continued on page 57)

# Let's Crack the 28-Mc. Nut

## Announcing Plans for Summer Short-Haul Work on Ten Meters

**F**OR about eight years we have owned a slice of private territory in the vicinity of 28 mc. During that time, many amateurs have made sporadic attempts to do something about it. Much time, energy, enthusiasm and power have been burned up in the process of establishing that, with our present technique, 28 mc. allows us to work any part of the world *once in a while*. Many indefatigable experimenters (particularly in foreign countries) clinging to their original hopes, are still spending much time looking for DX on the 28-mc. band; but most of us, having had our whirl, have been content to sit on our haunches waiting for the sun to change its spots.

For the last two years there has been an old dust-laden 28-mc. oscillator sitting undisturbed on a high shelf in the Headquarters' workshop. During the last few months, in particular, the set has had an unmistakable "come hither" look on its dial. Every time we glanced at the thing, it mumbled something about being able to do a better job of this short-haul stuff than its 56-mc. companions down on the table.

A few days ago we cleaned off this 28-mc. oscillator and dressed it up in similar fashion to one of the 56-mc. sets.

Both of them were placed on the roof of the office building and each hitched to a vertical half-wave antenna. Then, both of the oscillators were fed with 400 volts at 60 ma. and both were adjusted to give the same antenna current. A Class B modulator in the room below was then connected to modulate the two oscillators simultaneously with the output of a G.R. 1000-cycle oscillator. The layout was, of

course, relatively crude and intended merely to simulate two ordinary amateur transmitters operating in the ordinary manner.

With the two transmitters running, we then drove west in a super-regenerative equipped automobile, listening, for the first few miles, to the 56-mc. set. About five miles west of West Hartford is a range of hills running north and south and maintaining an average height of about 800 feet above the surrounding country.

As far as 56-mc. signals are concerned the range has always been an effective barrier to westward-bound signals. It was nothing new for us, therefore, to lose the five-meter signal at about the five-mile limit. We did prick up our ears, though, when we heard the 28-mc. signal still very strong. Continuing down the far side of the mountain and turning north for a five-mile stretch close under the lee of the range, we found the signal virtually unaffected. It was obviously a thrill to be able to hold a good R8 tone through miles of territory into which none of our 56-mc. signals had ever penetrated. But that wasn't all. Again turning west and driving over and beyond a whole series of ridges, we still held a steady signal, losing it suddenly as we dove into a valley about 18 miles from the start. On the return trip, nothing was heard of the 56-mc. transmitter until we pushed over the last ridge — four miles from home. We had to hand 28 mc. the palm.

This particular experiment does not mean, of course, that 28 mc. necessarily has the edge on 56 mc. However, it did serve to back up the contention, long held by many amateurs, that in a great many instances 28 mc. will be superior to

56 mc. for short-haul work.

Further comparative tests so bolstered our enthusiasm for 28 mc. that we made it our business to contact a few of the leaders of the 56-mc. movement in this part of New England. All of them were enthusiastic over the idea of a summer of comparative work on 56 and 28 mc. — so enthusiastic that their stations were on the air and working within 48 hours.

The merit of activity on 28 mc. is not merely that it will allow much inter-town and around town work impossible on 56 mc., but that it will populate the band with signals for the DX hunter. Activity on the band might be limited chiefly to around and about-town rag-chewing but there would always be the possibility of unexpected transient guests arriving over much DX to join the party.

As far as we can see, the only real problem which prevents us from making a wild dive into

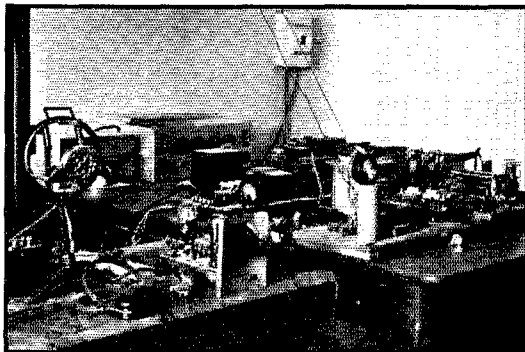

SOME OF THE EXPERIMENTAL ULTRA-HIGH FREQUENCY GEAR WITH WHICH COMPARATIVE TESTS WERE RUN ON 56 AND 28 MC. AT A.R.R.L. HEADQUARTERS

the 28-mc. band with modified 56-mc. transmitters and super-regenerative receivers is that the present regulations provide only for unmodulated continuous wave transmission on "ten." This means, of course, that what we should effect is more a migration from 14 mc. than from 56 mc. At the same time we might mention that A.R.R.L. has had on file with the Federal Radio Commission for about twelve months a request for the authorization of "A2" or tone-modulated transmission on 28 mc. for the express purpose of enabling the super-regenerative receiver again to be put to work. While this authorization has run into administrative delays, we have every reason to believe that it will be put through before the summer is far along.

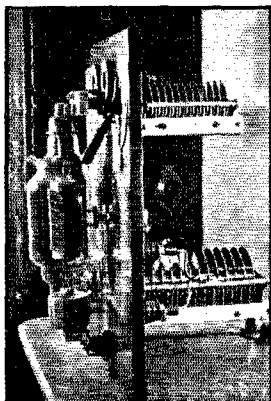

WISZ, DETERMINED TO EXPLOIT THE DX SIDE OF 28-MC. WORK THIS SUMMER, HAS RIGGED THIS AMPLIFIER WITH ONE OF THE NEW FEDERAL BOTTLES

Aside from the matter of regulation, it is obvious that we cannot expect to get very far with the type of gear used on 56 mc. The whole family of apparatus for that band was developed with the idea of side-tracking the frequency stability problem in the simplest possible manner. Successful occupancy of the band resulted exclusively from the utter simplicity of the apparatus necessary. The usual 56-mc. transmitter of to-day undoubtedly occupies a chunk of frequencies very much wider than that usurped by transmitters on other bands and they have been allowed to do so only because of the prohibitive complications considered necessary to prevent frequency instability and because the interference resulting was purely a local affair, of real consequence only in the larger cities.

On the 28-mc. band, the story is a different one. Even though we primarily use the band for short-haul work, we cannot escape a secondary interest in DX. When we least expect it, we will find our signals pushing out in great style, hashing up the band for everyone else or giving us good DX depending on whether the signals are rotten or not. In short, it should clearly be our aim to advance from the modulated oscillator and super-regenerative receiver to the oscillator-amplifier and superhet or autodyne.

The statement that we have been sneaking up to through all these words is simply this: Ap-

paratus or no apparatus, complications or no complications, the 28-mc. band is to be a swell hunting ground for this summer. Just as groups of practical pioneers licked "five" so will "ten" be licked. Drag out your 28-mc. transmitters and receivers, crew.

— R. A. H.

## Improving the Sensitivity of the S.S. "Five" Receiver

ADDITIONAL playing with the simplified S.S. receiver described last month has shown that the sensitivity is made even greater by a

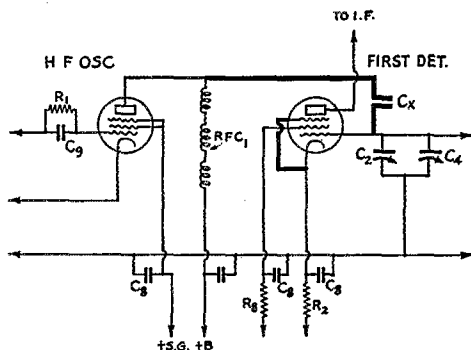

THE CHANGE IN CONNECTION IS SHOWN BY THE HEAVY LINES

The plate of the oscillator is coupled to the control grid of the first detector through the small condenser  $C_2$ . This condenser can be made up of a pair of "penny size" plates mounted on a scrap of bakelite with an airgap of about  $\frac{1}{8}$  to  $\frac{1}{4}$ -inch between their parallel faces. The suppressor grid is connected to the cathode in conventional fashion. No changes are made in the oscillator circuit.

slight change in the h.f. oscillator — first detector coupling arrangement. Although the scheme of coupling the oscillator plate to the suppressor grid of the detector gives the advantages mentioned in the article, their sacrifice by switching over to detector control-grid coupling is justified by the greater sensitivity that results, especially at the higher frequencies. The modified circuit is shown herewith.

— J. J. L.

## Strays

Nail polish sold at the five-and-ten stores is a good substitute for collodion or lacquer for holding coil windings in place.

— H. W. Gordon

Several of the gang have suggested having photostats made of operator licenses to be carried on trips so that the regulation requiring the display of such licenses can be complied with. A photostat is a legal copy — photographs are not.

# A Sensitive Tuning Indicator

By J. D. Blich, W4IS\*

THERE is a definite need for a "tuning lamp" more sensitive than the familiar flashlight bulb and turn or two of wire, especially for neutralizing and for tracking down stray r.f. The thermo-galvanometer has long been used for these purposes, and by proper consideration of the impedances involved it can be made fairly sensitive. But either of these devices is by comparison far less sensitive than the indicator to be described.

A stroke of lightning ruined the writer's thermo-galvanometer, and after some unsuccessful attempts at constructing thermo-couples which would give a full-scale deflection on a 1-mil. d.c. meter with an r.f. current of about 100 milliamperes, some thought was given to the possibilities of the copper-oxide rectifier. Accordingly a half-wave rectifier was made from a disc taken from an old trickle charger, using, at a guess, an active surface about two millimeters square. When this was hooked to the 1-mil meter and a pick-up coil it worked, although the sensitivity was far below expectations. But when the d.c. meter was shunted by a .001- $\mu$ fd. mica condenser the sensitivity went up magically. The purpose of the condenser is to accumulate the unidirectional high-frequency pulses. With a three-turn pickup coil it will give half-scale deflection six feet from the transmitter tank inductance.

To construct a miniature rectifier of this sort, cut a piece of rectifier disc about 3 by 5 millimeters, being careful not to damage the oxide surface. The copper side of this element should be cleaned with sandpaper and washed off with alcohol. Next a tab about 5 by 7 millimeters is cut from some heavy copper sheet. Then a piece of mica a little larger than the rectifier element is provided and in its center is cut a square hole 2 by 2 millimeters. A piece of mica of the same size, but without the hole, also is necessary. A piece of thin lead sheet 2 by 2 millimeters is cut, and finally a piece of copper foil 2 millimeters wide by six or eight millimeters long. This completes the list of parts necessary.

To assemble the rectifier, the copper tab is laid flat upon the table and upon it is placed the rectifier element, copper side down. Upon this is placed the piece of mica with hole in it. Over the hole is placed the lead tab and upon this the piece of copper foil which is to serve as one terminal. Finally the mica insulator is placed on top and the copper tab carefully bent over so as to surround the assembly. The unit is placed in a vise and pressed firmly. The lead tab will penetrate the

mica hole and make contact with the oxide surface. The other terminal is the copper tab itself and a wire may be soldered to it when the assembly is complete. When measured with a "one mil" ohmmeter the resistance should be not more than 200 ohms in the direction (polarity) of lowest resistance—the lower the better. Nearly zero resistance would indicate that the unit had shorted in the process of construction.

An alternative method of construction is simply to cut out a piece of rectifier disc a millimeter

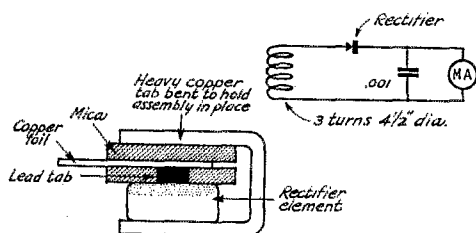

## CONSTRUCTION OF THE COPPER-OXIDE RECTIFIER FOR R.F. INDICATORS

The diagram below the drawing shows how the rectifier is used with a pickup coil and a 0-1 d.c. milliammeter.

or two square and solder the terminal wires directly to the two surfaces. In this way a unit can be made in a few minutes, but a special solder is required. A satisfactory solder for this purpose is "Lotan Super Solder," which comes in powdered form. It can be applied to the oxide surface with a pointed matchstick and the job completed with an ordinary soldering iron.

The sensitivity of the rectifier would be increased if its resistance could be lowered. This could be done by increasing the contact area but cannot be carried too far because the rectification efficiency depends in some fashion upon the current density. If the mica used in the construction is fairly thick the capacity of the unit will be small.

I have found it convenient to mount these rectifiers in 4-prong tube bases. If the two filament prongs of the socket are connected to the meter and the plate and grid terminals are connected to binding posts which in turn connect to the pickup coil, a very flexible arrangement results. A half-wave rectifier, a full-wave rectifier or any particular thermocouple can be plugged in at will.

\*Statesboro, Ga.

<sup>1</sup>Lotan Products Co., Cleveland, Ohio.

# Graduating to Oscillator-Amplifier Transmitters on 56 Mc.

By D. A. Griffin, W2AOE\*

FROM an amateur standpoint, 56 megacycles has now passed the stage of youthful growing pains and we are now ready for more mature development. Such further development may be of only passing interest to the ham located miles away from the nearest amateur QRM factory, but to those residing in metropolitan areas like New York City and suburbs, the QRM situation is already acute on 56 mc.

A super-regenerative receiver is ideal for the reception of a signal that is frequency-modulated a hundred kilocycles or so; but, unfortunately, ten or fifteen such signals will completely cover the entire band of 4000 kilocycles between 56 and 60 mc. The logical answer to the problem is, of course, first to stabilize transmitter frequency. Then the adoption of low-cost superhet receivers (which, incidentally, can have a better signal-to-noise ratio than the super-regenerative receiver) will naturally follow. We will then have room for simultaneous operation of four hundred stations in the band, allowing 10 kilocycles for each channel. No doubt the conversion process will be relatively slow, but it should be remembered that the stable signal will take less room on the super-regeneratives dial than the wobbly one, and that the use of stabilized transmitters generally will cut down QRM to some extent even with that kind of receiver.

The fact that a stable signal can be obtained readily on 5 meters, without any great difficulty, is not generally appreciated or we would certainly find more outfits of this type in use. The purpose of this article is to outline several such transmitters. To those already familiar with the "wobulator" type of transmitter on 56 mc., the transition to a stable transmitter should be easy. The ideal outfit for stability would be the crystal-controlled type. Doubling from an 80- or 40-meter crystal oscillator in a conventional manner may be accomplished if a few rules concerning the ultra-high-frequency stages are followed. The disadvantage of this type of transmitter is that it takes quite a bit of apparatus and space, and is inflexible as to frequency if only one crystal is available. W2KV has had a transmitter of this type in operation for some time, and the high quality and steadiness of his signals are well-known to New Jersey 56-mc. experimenters.

Direct tourmaline crystal control on 56 mc. is beyond the reach of most amateurs because of the cost of tourmaline crystals ground to these frequencies. The simplest stable transmitter is of the two-stage type employing a 56-mc. oscillator and a 56-mc. neutralized amplifier. W2AG has developed the simple outfit shown in Fig. 1 and many amateurs are following his example.

Referring to Fig. 1, we find the usual 10 push-pull oscillator converted into a neutralized amplifier of the conventional type, the only unusual feature being the use of a tuned grid circuit. This amplifier is excited by a pair of 12-A's in a high-*C* TNT oscillator. With the oscillator operating on its own power supply, this type of transmitter is surprisingly free from frequency modulation and the output is equal to that obtained from a self-excited oscillator running at the same plate voltage. The only disadvantage with this type of transmitter is that the frequency

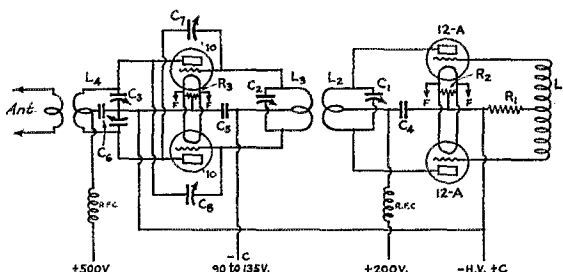

FIG. 1 — THE SIMPLE OSCILLATOR-AMPLIFIER RIG AS USED BY W2AG

- $L_1$  — 6 turns, 1-inch diameter.
- $L_2$  — 2 turns, 1½-inch diameter.
- $L_3$  — 2 turns, 2-inch diameter.
- $L_4$  — 2 turns, 2½-inch diameter.
- $C_1, C_2$  — 50- $\mu\text{f}$ d. variables.
- $C_3$  — Split-stator variable, 35- $\mu\text{f}$ d. per section.
- $C_4, C_5, C_6$  — 500- $\mu\text{f}$ d. or larger, mica fixed.
- $C_7, C_8$  — 35- $\mu\text{f}$ d., neutralizing condensers.
- $R_1$  — 20,000-ohm 5-watt.
- $R_2, R_3$  — 75-ohm filament center taps.
- RFC — National No. 100 r.f. chokes.

of the controlling oscillator may drift considerably with heating of the tubes. This is of negligible importance with the broad tuning super-regenerative receiver, but would necessitate chasing the signal with the more selective superhet receiver as the oscillator tubes continue to warm up.

## DOUBLING AND TRIPILING

To reduce frequency modulation still further and to hold the drift to an order comparable with

\* Leeds, 45 Veasey St., New York, N. Y.

crystal control, the circuit outlined in Fig. 2 was developed here. The oscillator is of the high-*C* type, operating on 10 mc. (30 meters). There are two reasons for this: first, it leaves the 14-mc. band free of harmonics so that simultaneous operation on 5 and 20 can be enjoyed; and second, at 10 mc. the oscillator is far more stable than it would be if operated on 14, 20 or 28 mc., with subsequent doublers or triplers.

In the first set-up a 10 oscillator was used, followed by a 46 doubler. Then it was found that a single 59 doubling in its plate circuit gave comparable results. With the 59 plate circuit tuned to 20 mc., a pair of 46's follow in a push-pull tripler stage, the 46 output being tuned to 60 mc. This arrangement was found to be far superior to tripling first to 30 mc. and then doubling in a single-ended amplifier to 60 mc. In tripling, advantage is taken of the fact that

would do. A pair of 46's follow in a conventional neutralized Class C amplifier modulated by 10's in a Class B audio system.

The arrangement of the relay in the oscillator r.f. circuit is of considerable interest. The oscillator runs constantly and after the initial drift which is rapid for the first few minutes, little creeping takes place. It will be noted that the "B" supply to the oscillator plate and to the tripler stage is cut off when the relay is open. The oscillator is then tuned by *C*<sub>1</sub> so that its harmonics fall outside of the 56-mc. band. At 10.5 mc. the fifth and sixth harmonics fall at 52.5 mc. and 63 mc., so that the receiver is not blocked although the oscillator is running at normal output. With the relay closed, *C*<sub>2</sub> is shunted across *C*<sub>1</sub>. The oscillator is then tuned to a frequency between 9.3 mc. and 10 mc., so that the sixth harmonic falls within the band. The

power is simultaneously supplied to the plate and to the tripler stage. These circuits are then tuned and the final amplifier is properly excited. It is of course necessary to tune up the outfit after the oscillator has been running a few minutes.

Most 56-mc. experimenters need no more than this brief outline to get started. The do's and don'ts listed below will save considerable time, however, and

assure results with minimum difficulty. All the principles involved are exactly the same as those applied to low-frequency m.o.p.a. transmitters.

But the little details so often neglected at lower frequencies are of prime importance at the ultra-high frequencies and strict attention must be paid to them to insure success.

Low-loss sockets and condensers are to be preferred. The coils should be made of 1/8-inch tubing or a larger size if possible. Tank leads should be as near non-existent as possible. Fastening the coils directly to the tuning condensers solves this problem. Couplings with insulated shafts should be used on all condensers tuning circuits above 10 mc. Vernier dials make tuning much easier and more accurate. Mechanical rigidity is of paramount importance — wobbling leads cause instability and varying output.

It is necessary to use a tuned grid circuit in the final amplifier to provide a decent value of impedance across which the exciting voltage may be developed. Conductive or capacitive coupling is very unsatisfactory. The distance between the amplifier grid coil and the plate tank of the

(Continued on page 68)

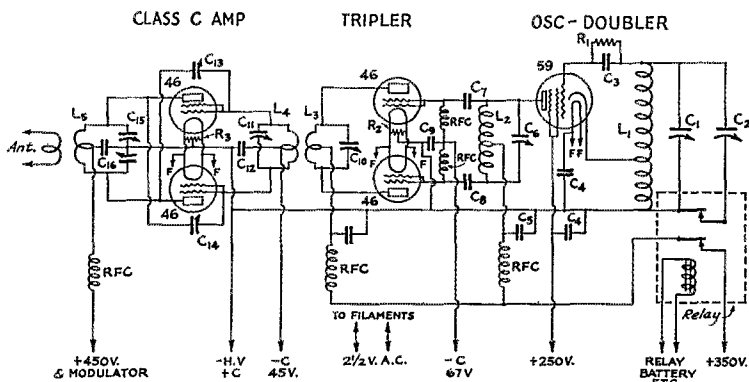

FIG. 2—THE DOUBLING AND TRIPLING TRANSMITTER USED AT W2AOE

- C*<sub>1</sub> — 350- $\mu$ fd. variable.
  - C*<sub>2</sub> — 100- $\mu$ fd. variable.
  - C*<sub>3</sub> — 100- $\mu$ fd. fixed mica.
  - C*<sub>4</sub> — .005- $\mu$ fd. mica by-pass.
  - C*<sub>5</sub> — 500- $\mu$ fd. mica by-pass.
  - C*<sub>6</sub> — 100- $\mu$ fd. variable.
  - C*<sub>7</sub>, *C*<sub>8</sub> — 40- $\mu$ fd. mica coupling condensers.
  - C*<sub>9</sub> — 500- $\mu$ fd. mica by-pass.
  - C*<sub>10</sub> — 50- $\mu$ fd. variable.
  - C*<sub>11</sub> — 50- $\mu$ fd. variable.
  - C*<sub>12</sub> — 500- $\mu$ fd. mica by-pass.
  - C*<sub>13</sub>, *C*<sub>14</sub> — 25- $\mu$ fd. neutralizing condensers.
  - C*<sub>15</sub> — Split-stator variable, 35- $\mu$ fd. per section.
  - C*<sub>16</sub> — 500- $\mu$ fd. mica by-pass.
  - R*<sub>1</sub> — 10,000-ohm 5-watt.
  - R*<sub>2</sub>, *R*<sub>3</sub> — 20-ohm center-tapped.
  - L*<sub>1</sub> — 4 turns 3/16-inch copper tubing, 2 1/2-inch diameter. Turns spaced 3/16-inch. Cathode tap 1 1/2 turns from ground end.
  - L*<sub>2</sub> — Same as *L*<sub>1</sub> but no tap.
  - L*<sub>3</sub>, *L*<sub>4</sub> — 2 turns 3/16-inch copper tubing, 2-inch diameter, spaced 1/2-inch between turns. Tapped at center.
  - L*<sub>5</sub> — 2 turns 3/16-inch copper tubing, 2 1/2-inch diameter, 1/2-inch between turns.
  - RFC — National No. 100 r.f. chokes.
- Relay is double-pole single-throw type for operation on either a.c. or d.c. A d.p.s.t. switch could be used instead.

the odd harmonics do not cancel out in a push-pull stage, as do the even harmonics. The plates of the 46's are effectively in series giving higher efficiency than a single tube or tubes in parallel



# Improving the 56-Mc. Receiver

## Constructional Details of Two New Sets for the Ultra-High Frequencies

By Calvin F. Hadlock, WIFFR\*

**A**LTHOUGH the "Five-Meter Band" has seen amateur activity for about eight years, it has not been occupied extensively, until a little less than two years ago, when practical apparatus of the modern era was presented in *QST*. Most of the early work was on c.w. and DX was the objective. It was not until we turned to 'phone and outgrew the longing for extreme DX that we saw the usefulness of the band in its true light. To-day, thousands of amateurs all over our country and in many foreign countries are using the band daily for local QSO's on 'phone. We still get the DX thrill when we work a station fifty miles away but we are usually content to chat with the boys around town.

However, recent technical progress on this band has been extremely slow. The transmitters are still chiefly modulated oscillators which, because of the heavy frequency modulation, usually require a receiver that tunes broadly in order to receive them without too much distortion. The superheterodyne and the converter are handicapped by their inability to bring these frequency modulated signals in clearly; but the fault actually lies in the transmitters. Certainly it would seem that the only practical receiver to use on this type of signal is the super-regenerative receiver, although in the near future, when we all start using reasonably stable transmitters, the five-meter superheterodynes and converters will be able to reveal their real value. The super-regenerative receiver is satisfactory because it has the same fault as the usual transmitter; that is, wobble. The receiver has an oscillating detector (or one nearly oscillating) which is modulated by a low frequency oscillator, the wobble of the detector causing the receiver to tune very broadly. Thus two wrongs are caused to make a right. It is, however, quite apparent that this type of receiver will be used extensively for a few years to come so an effort has

been made to see what can be done to improve it.

Practically all of the receivers in use to-day on the five-meter band are copies of the receiver originally described in *QST* (July, 1931). Therefore, this receiver was taken as a starting point.

With this type of set, when duplex work is attempted, it is found that, with the transmitter turned on, we are likely to hear all kinds of long-wave, broadcast and even television signals on each side of the transmitter frequency which normally have no business showing up on a five-meter receiver. This results from the series-tuned type of detector input circuit used. Broadcast signals build up appreciable voltage between the grid of the tube and ground and produce cross-modulation. This effect often interferes seriously with duplex work. We also find that when we connect the antenna to the receiver we get the usual dead spots and the effect on regeneration that always occurs when we attempt to couple an antenna to a regenerative detector. Finally, the receiver is good on five meters only, since very few of these receivers use plug-in coils.

It was decided to build up a preliminary model which would be used for trying out a modified circuit for correcting the above-named faults and then to build a later model using this same circuit but adding a stage of tuned radio-frequency amplification.

The final detector circuit decided upon was a '24-A screen-grid tube arranged in the now familiar electron-coupled circuit. The screen grid acts

as the plate of the r.f. oscillator while the audio is taken out in the plate circuit. The long-wave modulator was connected into the screen grid, thereby modulating the r.f. oscillator by varying the screen-grid voltage. It would appear that both the coils comprising the long wave oscillator transformer are untuned. However, they are arranged in a tuned plate circuit with the grid coil acting as a tickler. The condenser  $C_4$  acts not only as a

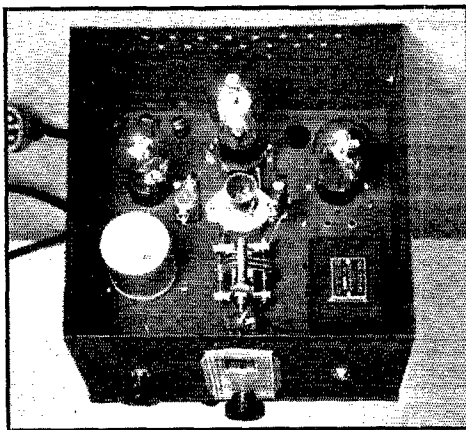

THE PRELIMINARY THREE-TUBE SUPER-REGENERATIVE RECEIVER

\* 6 Warren Ave., Greenwood, Mass.

ground for the screen grid but also as the tuning condenser across the long-wave plate coil  $L_4$ . If the grid coil is not large enough, a small condenser may be required to tune it also.  $L_3$  must be a good long-wave choke. The effectiveness of the filter in the plate circuit can be tested with the receiver in operation by putting a high resistance voltmeter

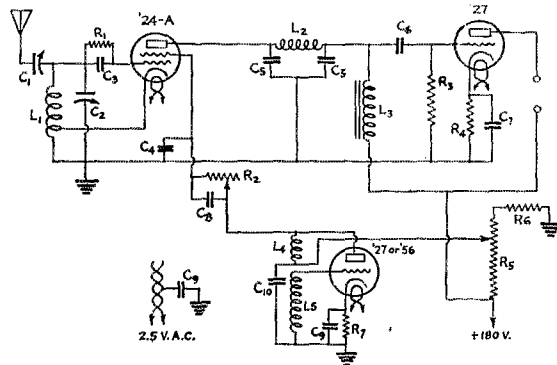

FIG. 1

- $C_1$  — Very small compression type mica trimmer condenser.
- $C_2$  — 12- $\mu$ fd. variable condenser (same as on r.f. detector and r.f. tuning condensers).
- $C_3$  — Small mica .0001- $\mu$ fd. condenser.
- $C_4$  — .001- to .002- $\mu$ fd. mica condenser.
- $C_5$  — .001- $\mu$ fd. condenser.
- $C_7$  — .5  $\mu$ fd. or more.
- $C_8$  — .5  $\mu$ fd. or more.
- $C_9$  — .01  $\mu$ fd. or more.
- $C_{10}$  — .5  $\mu$ fd. or more.
- $R_1$  —  $\frac{1}{2}$  watt, 5 megohm.
- $R_2$  — 50,000 rheostat.
- $R_4$  — 2,000 ohms, 1 watt.
- $R_5$  — 12,000-ohm voltage divider.
- $R_6$  — Additional resistors to fix reg. point.
- $R_7$  — 2,000-ohm, 1 watt.
- $L_1$  — Detector coil. Two turns, 1-inch diameter. Tap one-quarter turn from grounded end.
- $L_2$  — 250 millihenry r.f. choke.
- $L_3, C_6, R_3$  — Parts of National S101.
- $L_4$  — 600 turn, 175-kc. i.f. coil.
- $L_5$  — Three or four times larger than  $L_4$ .

between the grid of the audio tube and ground. If a reading is obtained, the plate filter must be improved. Care must be taken that  $C_5$  is not of such a value as to tune the filter to the frequency of the long-wave oscillator. If such a value is tried, more grid voltage will appear on the audio tube than with no condenser at all. Two .001- $\mu$ fd. condensers for  $C_5$  were entirely adequate while still not cutting down the audio output appreciably.

Now let us see how many of the faults of the old type receiver we have corrected. First, this receiver uses parallel tuning but allows a reasonable amount of tuning inductance since the minimum capacity has been kept down to a very low value. The setting of the regeneration control is practically the same over the entire range of the receiver. Cross-modulation with broadcast stations and other lower frequencies has disappeared entirely. The sensitivity and output of the receiver are much better than with the old circuit.

It was found impossible to keep the headphones on the head and the 27 audio would push a loud-speaker in great style. A further advantage is that by the use of proper coils, this receiver can be used on any amateur band.

With the preliminary model finished, we now built the t.r.f. receiver which was to have still further advantages. As seen in Fig. 2, the detector circuit is similar to that of the preliminary model, with two exceptions. First, a switch for applying or removing super-regeneration to the detector has been added. This switch, marked "SW," is a single-pole double-throw toggle switch. When snapped to the right, the receiver operates exactly as did the preliminary model. When snapped to the left, it places a large capacity across the plate coil of the long-wave oscillator to prevent it from oscillating. At the same time the switch grounds one end of the 50,000-ohm potentiometer and places a large capacity between the arm and ground, thereby preventing noise as the arm is rotated. In this position regeneration is controlled by varying the detector screen voltage in the manner which has been commonly used before.

The second change in the detector circuit is the addition of a tap to the inductance of the audio unit, producing a step-down auto-transformer which has an impedance ratio of about 25 to 1. This very nearly matches the impedance of the average headphones. Thus we are able to use headphones efficiently in the plate circuit of a screen-grid detector. The 'phone jack has a third arm so arranged that when the 'phone plug is inserted, the loud speaker is short circuited. The

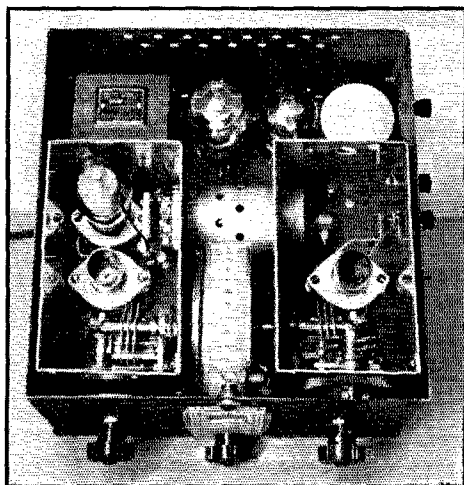

PLAN VIEW OF THE FOUR-TUBE MODEL IN WHICH AN R.F. AMPLIFIER PRECEDES THE SUPER-REGENERATIVE DETECTOR

long-wave oscillator, incidentally, is identical with that in the preliminary model.

The audio uses a Type 59 or 2A5 tube connected up as a pentode. This connection gives about one watt output at the voltage used, and provides plenty of sock for a loud speaker. A volume control has been added, as this is a desirable refinement. The cathode is biased, while the heaters are center-tapped and grounded inside the power supply unit. The cathode bias resistor is by-passed by a 10- $\mu$ fd. electrolytic condenser. If a large by-pass condenser is not available, it may be desirable to use a grid filter system to obtain the best quality.

#### THE TUNED R.F. STAGE

The stage of tuned r.f. amplification is the most important part of this receiver. In the photograph, the dial is seen in the middle of the cabinet with the r.f. shield compartment on the right and the detector shield compartment on the left. The variable condensers are supported from the subpanel by brackets which are also the ground for the tuned circuit. The leads to the coil socket from the tuning condensers and the detector cathode should be short, rigid and well away from the subpanel. The leads to the r.f. tuning condenser from the r.f. coil should be as nearly identical as possible to the leads to the detector tuning condenser from the detector coil, to insure ganging of the two stages. A large hole punched in the subpanel directly beneath each tuning condenser facilitates soldering to the condensers after they are in place. The r.f. coil is identical to the detector coil with the exception that the tap is omitted and an antenna coupling coil of two or three turns of wire is placed in a small groove located next to the tuning coil. This coil is brought out to the remaining two prongs on the coil form.

The r.f. amplifier tube is a Type 58 tube which is far superior to any other common tube yet produced as an r.f. amplifier on 56 mc. This tube is placed horizontally just behind the tuning dial "à la Ross Hull." The socket and shield can is mounted on the side of the detector shield compartment while the control grid cap is inside of the r.f. shield compartment. This sort of mounting gives a very short grid lead while the length of the r.f. plate lead is exactly zero. The plate coupling condenser has one end soldered to the plate prong on the 58 tube socket while the other end is soldered to the bottom of the detector grid con-

denser which is mounted on top of the detector coil socket.

The r.f. trimmer condenser  $C_1$  is mounted near the top of the r.f. shield compartment with short bus bar leads running directly down to the r.f. tuning condenser beneath it. It is rotated by means of the bakelite disc and there is a slot in the cover to allow turning this disc with the cover on. At the back left is seen the audio transformer unit and the Type 59 audio tube, while at the back right is seen the shield can containing the long-wave oscillation transformer and the '27 long-wave oscillator tube. The choke  $L_3$  must be an efficient one of very low distributed capacity.

One difficulty was met with when the set was first tried out. The detector did not oscillate easily and when it did oscillate, the range of the tuning

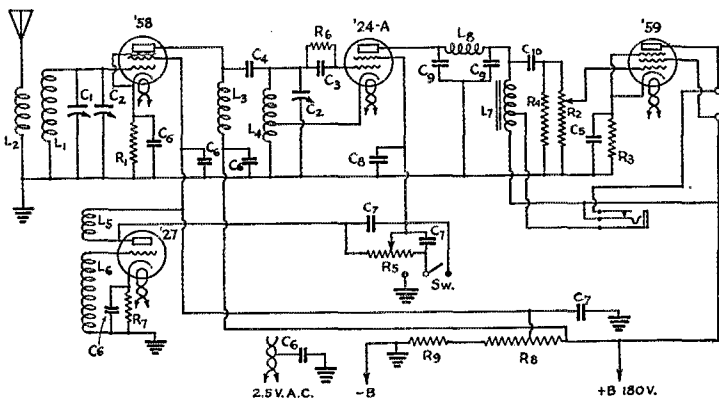

FIG. 2 — THE CIRCUIT OF THE FINAL MODEL

$C_1$  — National SEU12 — two stator and three rotor plates, double spaced.

$C_2$  — National STN12 or other condensers of approximately 12  $\mu$ fd.

$C_3$  — .0001- $\mu$ fd. mica.

$C_4$  — Described in text.

$C_5$  — 10- $\mu$ fd. electrolytic.

$C_6$  — .01- $\mu$ fd. mica.

$C_7$  — .5 $\mu$ fd.

$C_8$  — .001- to .002- $\mu$ fd. mica.

$C_9$  — .001- $\mu$ fd. mica.

$R_1$  — 300 ohms.

$R_2$  — 5-megohm potentiometer.

$R_3$  — 500 ohms.

$R_4, L_7, C_{10}$  — National S101-T coupling unit.

$R_5$  — 50,000-ohm potentiometer.

$R_6$  — 5 megohms.

$R_7$  — 2000 ohms, 1 watt.

$R_8, R_9$  — Same as  $R_6, R_6$  of Fig. 1.

$L_1, L_4$  — Each two turns 1-inch diameter —  $L_4$  tapped one-quarter turn from grounded end. Four turns in same space would serve for 28-mc. band.

$L_2$  — Two or three turns.

$L_3$  — National Type 100 U.H.F. R. F. Choke.

$L_5, L_6$  — Same as  $L_4, L_5$  in Fig. 1.

$L_8$  — 250 millihenry r.f. choke.

system was found to be down near seven meters. A 250- $\mu$ fd. condenser was used as  $C_4$  at the time. Attempts to lower the wavelength made ridiculously small coils necessary, and then the detector would not oscillate at five meters at all. When the r.f. tube was removed from its socket, the detector oscillated freely and the wavelength range was lowered somewhat. Then the condenser  $C_4$  was

removed, the wavelength was lowered still more. The change in wavelength was obviously due to the r.f. tube capacity plus the capacity of the r.f. choke. The only cure was to reduce the capacity of the condenser  $C_4$ . Calculation showed that this capacity could be reduced to 10  $\mu\text{fd.}$  with very little signal loss. This condenser was made by riveting two strips of metal about  $\frac{1}{4}$ -inch wide and an inch long on a piece of Isolantite with a strip of mica between them. They were squeezed

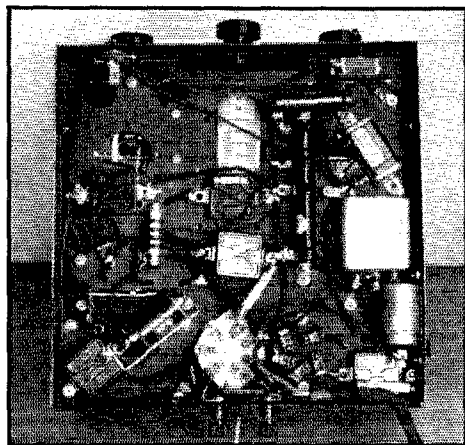

UNDERNEATH THE FOUR-TUBE ULTRA-HIGH FREQUENCY RECEIVER

together until the five-meter band came about the middle of the dial and the detector oscillated with about 70 volts on the screen.

It is extremely hard to measure the gain of an amplifier at five meters, but a reasonable guess can be made by comparing the pick-up of this receiver with that of the original model. This was done one Sunday afternoon while operating WICTW at my home in Greenwood, Mass. I hooked up with W1CCX of Revere, and he patiently talked for about twenty minutes while I swapped back and forth from one receiver to the other using the same antenna for both sets. My estimate is that there was a gain of about eight times.

To mention a few other operating characteristics of this receiver, only a slight improvement in selectivity is noticeable as determined by attempting to separate two strong adjacent signals. This test was made by having W1BJN and W1EMF, both of Melrose, adjust their frequencies until they came in about five dial divisions apart and then test while I tried to separate them on each receiver in turn. However, the marked improvement introduced by the addition of a stage of tuned radio frequency amplification is not just selectivity, which we naturally think of first. One very great improvement is the fact that any kind of an antenna — long, short, tuned or untuned —

could be coupled closely without affecting the regeneration control in the least. Another great improvement is the fact that the oscillating detector cannot radiate appreciably from the antenna because there is a screen-grid tube located between it and the antenna. This point is becoming more and more important as the band becomes more crowded and the use of tuned antennas for receiving becomes more common. Vicious local interference can be caused by oscillating detectors radiating from the receiving antennas connected to them. In one instance a super-regenerative receiver located in Waltham, Mass., was heard on Mt. Wachusett, nearly fifty miles away.

This receiver has been in constant use at WICTW and also at portable station W1FFR for nearly two months. During that time I have received about thirty-five different stations around greater Boston at distances up to twenty-five miles. I have picked up several new stations that have been on the air constantly but that I could not hear before, among them W1DPP in West Concord, W1SV in Brookline, W1KH in Weston and W1BVL in Dorchester.

This receiver can be adapted for use on lower frequencies by the use of suitable plug-in coils. Better operation will probably be obtained by using a much larger value for  $C_4$  for the longer wavelengths. As a suggestion, a 100- or 250- $\mu\text{fd.}$  condenser could be connected in series with the 10- $\mu\text{fd.}$  condenser used for five-meter operation. This could be connected so that a strap inside of the coil going to the now unused fourth prong on the detector coil socket would short out the low capacity condenser and leave only the larger condenser in the circuit.

## 56-Mc. Airplane Tests

THE first of what is hoped will be a series of high-altitude five-meter tests is planned for Sunday, May 7th by W1COO. The schedule provides for an hour's flying at 15,000 feet with a transmitter operating on 60 mc. under the call W10XU. The first call will be made at 3 p.m. E.S.T. and during the first portion of the test period contact will be limited to stations in the Boston area. The second half-hour will be devoted to a search for DX contacts, with the particular hope of working stations in or around New York. Arrangements in the New York area are in the hands of W2FN. W1AHB, operating simultaneously on 56 mc. and 3500-ke. phone will stand prepared to relay reports of reception to the plane. In case of unfavorable weather, the flight will be made on the following Sunday.

As we go to press, we learn that W1XL, operating in a Conn. Department of Aeronautics plane, will be in and on the air during the afternoon of May 7, in the vicinity of Hartford.

# Erecting a 90-Foot Mast With a Tire Jack

By E. W. Lincoln, WIBNM\*

**M**ANY amateurs whose stations are located behind tall buildings or surrounded by trees want to get their sky pieces above these obstacles. Others, located in cities, have back yards of limited area and cannot tip up tall masts in the conventional manner.

The purpose of this article is to describe a practical method by which a high mast can be erected in the vertical position, using an ordinary tire jack to raise it. Theoretically, the height of such a mast is unlimited, but practically about 100 feet is all the average amateur can handle. Putting up a mast by this method, while comparatively slow, is quite easy and can be done single-handed to about 70 feet after which it is necessary to have three additional men to pay out the guy wires. A further advantage is that an amateur can put up his mast in spare time, boosting it up a few feet when he has the chance and leaving off whenever he pleases.

Fig. 1 shows a front view of the mast and the method used for splicing the 20-foot sections of 2 by 4's. As the sketch shows, the mast is built double right up to the top, with splices alternating first on one side, then the other. The spacers are 5-foot pieces of 2 by 4's and four 1/2-inch carriage bolts fasten each splice together.

When buying the 2 by 4's go to the lumber yard yourself and select pieces free from large knots. If it is impossible to get pieces which are perfectly straight, pick out the bent sections and pair them up so that they oppose each other, thus straightening both pieces. Next lay out the mast on the ground to bore the holes and number the pieces successively so that they will go together exactly the same way as they were bored. If the back yard won't accommodate the whole mast make it in two parts — but make sure the parts fit. Make a galvanized fastening for the pulley block on top of the mast and fasten the three top guys about 6 or 8 inches below. Needless to say, a couple of coats of paint will preserve the wood and make a finer appearance.

When the time comes to erect the mast, take apart the top section you choose to tip up. This can be 20, 30 or 40 feet. A 30-foot section makes

an easy job if help is limited. Get two additional 2 by 4's to act as guides and set one up on each side of the mast. Referring to Fig. 2, it is seen that the guides are put on front and back of the mast so as not to interfere with the bolting operation. Guy these guides in four directions as indicated and lash them tightly against the mast with rope. Now get out your tire jack and get under the

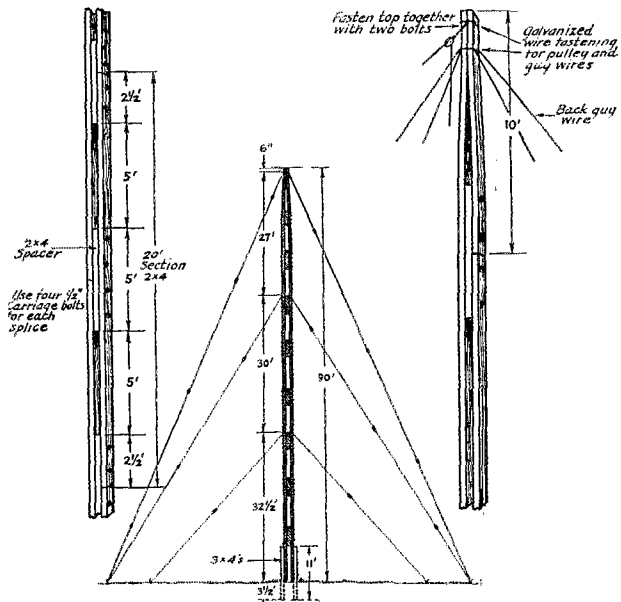

FIG. 1 — THE COMPLETED MAST AND DETAILS OF CONSTRUCTION

Made from 2 by 4's, this mast can be literally pushed up by one man with the help of a tire jack. The drawing at the left shows the section splicing details, while that at the right shows how to finish off the top section.

section resting on the ground. Raise the pole the limit of the jack — usually about 6 inches. Fig. 2 shows a method that may be used to prevent the mast from coming down while getting a new grip with the jack. Continue to block up the jack until the pole is ten feet off the ground after which a 20-foot section can be bolted on. It may be easier to bolt on a temporary 5-foot piece (when the mast is high enough off the ground) in which case the jack will be only 5 feet from ground at the highest point. If this is done a series of holes 6 inches apart can be made in the piece, to be used for blocking the fall of the mast when getting a new grip with the jack. Plenty of other methods will suggest themselves after one or two sections have been put on.

\* Box 158, North Dighton, Mass.

Feed out the guys as the pole goes up, fastening on the insulators at intervals, and putting on the second set of guys 27½ feet from the top. With a 90-foot mast a third set of guys is desirable, and should be fastened 32½ feet off the ground. Three sets of guy wires not only straighten

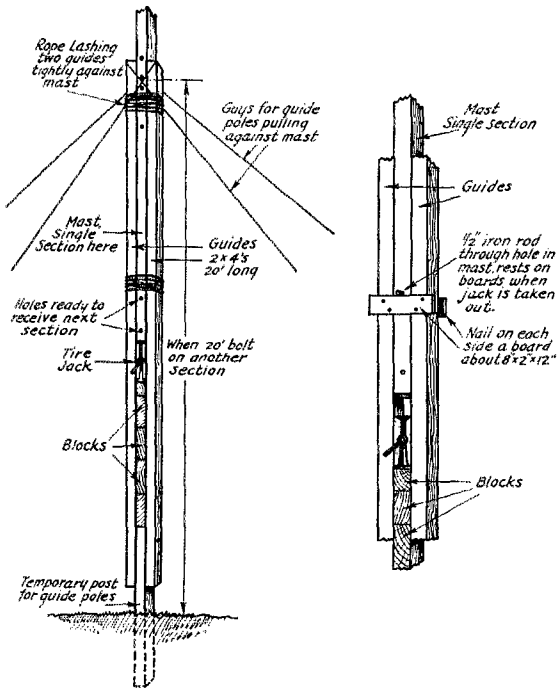

FIG. 2 — HOW THE JACK IS USED TO RAISE THE MAST  
A pair of guide posts holds the single end section in place while the jack is used to boost it. As the mast goes up a distance equal to the lift of the jack, blocks are slipped in to keep it from sliding back. The drawing at the right shows how the mast can be secured while the jack is taken out to put in new blocks. A ladder at least as long as the guide posts will be needed unless auxiliary 2 by 4 sections are used as boosters as described in the text.

up the mast but make it solid in a heavy wind. For finishing up I would suggest two 3 by 4's about 11 feet long, planted firmly in the ground one on each side of the mast. A good solid ground connection makes a steadier mast.

For anchorage (for the guy wires) use long iron pipes as wood soon rots off or pulls up in a wind. Last but not least, if Manila hemp rope is used rig up some kind of spring so that when the rope shrinks in wet weather the extra strain will not come on the mast or the antenna system.

### New Tube Type Designations

THROUGH the courtesy of Mr. Virgil M. Graham we have the following information to offer on the new tube-numbering system, which has been adopted as standard by the Radio Manufacturers Association:

The first digit (or two digits) indicates the

filament voltage in steps of one volt. The figure 1 is used for voltages below 2.1, the figure 2 for voltages between 2.1 and 2.9, the figure 3 for voltages between 3.0 and 3.9, etc. Thus a battery tube of the two-volt series will carry the number 1, a 2.5-volt tube the number 2, and so on.

The letter which follows the first numeral is a serial designation. Rectifiers start with Z and go backwards through the alphabet; all other tubes begin with A and move along normally.

The number following the letter indicates the number of useful elements in the tube brought out to terminals. A filament or heater counts as one element, for example, although it takes two of the tube terminals. An indirectly-heated cathode is a separate "useful element." Grids inside the tube which are connected internally but do not have separate terminals are not counted for purposes of tube numbering.

The 2A7 and 2B7 are excellent examples of the numbering system. The 2A7 has a heater, cathode, plate and five grids. One of the grids, however, is connected to another inside the tube and does not have a separate external connection, so there are seven useful elements. This is the first 2.5-volt tube with seven useful elements and therefore carries the letter A. The 2B7, having a heater, cathode, plate, two diode plates, control grid, screen grid and suppressor, the latter connected internally to the screen, also has seven useful elements. Since this is the second 2.5-volt tube with seven useful elements, it carries the letter B.

In tubes with several grids, the standard method of identification is to number the grids consecutively starting from the cathode.

### Strays

W1BFU and W1CGB are racing for honor of being the heaviest ham in the 1st district. BFU is ahead at the moment, weighing 297 pounds, with CGB at 262.

### Hudson Division Convention

May 25th-26th-27th, at Hotel St. George, Brooklyn, N. Y.

Banquet Saturday, 27th. Convention fee, including banquet, \$2.25. For those who cannot attend banquet, special daily admission of 35 cents will be available. Further information may be obtained from S. M. Riccobono, Chairman, 4305 Church Ave., Brooklyn, N. Y.

# Was This "The Old Man"?

As Told to R. B. Bourne, WIANA\*

FROM time to time we amateurs have read articles by The Old Man, heard rumors about him, wondered who he was, and altogether enjoyed the idea of having a bit of mystery associated with our hobby. For The Old Man has certainly kept his tracks well covered. All of us who are acquainted with The Old Man legend (and who isn't?) must have finally come to the conclusion that he is a very real person, who writes in an inimitable style and possesses a keen analytical mind. Personally I long since decided that he was probably not as old as he would have us think; he must be some well known amateur with a secret contact with the Editor. I am positive his identity is generally unknown at the League headquarters. I have seen his signature and, although I am no handwriting expert, I may say that it is certainly not that of one suspect I had in mind.

And now, let me set down the facts relating to a very mild adventure which might happen to anyone. A curious train of circumstances conspired to give me one of the biggest thrills I have ever received in connection with amateur radio — a connection of some twenty-four years.

I must remain anonymous, out of fairness to those concerned but, lest anyone prematurely conclude this narrative, I am *not* The Old Man! Whether or not I have seen him and been entertained by him, I must leave to you.

I do a considerable amount of traveling by auto, in the ordinary course of my business. Of late years, I have made it a practice to patronize tourist lodging houses and the like, in preference to hotels in the cities, where one-night stays were involved. It was at one of these homes that adventure befell me.

Anticipating a hard day on the morrow, I stopped rather early one evening at a neat white house on the outskirts of a town of perhaps fifteen thousand. There was no large electric sign out on the lawn — just a small card in the window with the single word "Guests" printed on it. The general impression was that of refinement.

In answer to my ring at the door, there appeared a pleasantly spoken lady of perhaps thirty-five years. Arrangements were quickly made and I was shown to my room.

"If you wish, you may come down and use our sitting room for the evening. Only Father will be there and I'm sure you won't mind," said the lady, as she withdrew.

I had a number of accounts to go over in preparation for the next day's calls, but when these were finished, and I had tidied up a bit, I went

down to the parlor, prepared to read until I grew sleepy. An elderly gentleman in shirt sleeves and suspenders greeted me.

"Howdy," said he, rising from his chair by the fire and adjusting his spectacles. "Been quite a spell since we've had a guest, what with the hard times and bein' off the main road. Fact, that's one reason I picked this spot, but you'd never guess why!"

"It's certainly nice and cozy here and I'm sure I shall enjoy my brief stay," I replied.

"Yes, we've been pretty comfortable out here. Retired 'bout ten years ago and bought this little place. Like it, too. Up high on a ridge. Fact, that's one reason I picked this spot, but you'd never guess why!"

"Well," said I, "*my* reason for picking a high place would be to get a good radio location, but I don't suppose you had anything like that in mind."

"Are you a HAM?" he asked with startling suddenness. "I've got a sked with 9 — in fifteen minutes!"

To say I was surprised would be to put it mildly. I looked the old fellow over more closely. It was highly improbable that he could have much of a rig, even if he were a ham. It just didn't fit. But he had used unmistakable ham language.

"I sure am," said I, and mutual introductions followed.

"Let's go out to the shack where we can have things to ourselves. Like you to see the outfit. Want to pound brass for a spell?"

"Suits me to a tee," and I followed him out to a back room which was my idea of a ham's paradise. Who would have suspected it?

"Here's my hangout. Have a chair — Kitty! Consarn that cat. Some day I won't see her when I start up. Always picks that bank of filter condensers for a place to sleep."

There was practically nothing in the room that didn't have to do with amateur radio. Plenty of desk and table space for operating and tinkering. Bookshelves along the wall contained bound volumes of *QST* and several feet of unbound I.R.E. "Proceedings." Some of the space was occupied by the usual spare parts, junk and things that only accumulate with the years in any ham station.

"I should say that you are a regular old-timer at this game," I remarked, as he carefully reamed out an ancient corncob pipe, knocking the sludge into a wastebasket.

"Uh-huh," said he, "been at it quite a spell. Got some old relics of the spark days down cellar.

\*80 Hillcrest Ave., Wethersfield, Conn.

Couldn't bear to throw 'em away when we moved. The old lady raised a fuss over it, but I got 'em down here just the same. Got a pipe? Can't smoke a pipe out in front, but this here is my shack and anything goes. Don't take to cigarettes much, though."

Presently he sat down and started up his rig — a pair of fifty-watters in what looked like t.p.t.g. p.p. I looked around the room as he tried to contact his 9. What familiar chord did all this strike? I couldn't place it. Here was probably the country's oldest ham. I could see how this hobby made his declining years pass swiftly and pleasantly.

"The skip is on and I can't raise him," he announced presently. "Mighty funny thing about that skip business. Another kind of rotten radio, if you get me."

I almost fell off the chair, so great was the shock I received at that. Rotten radio — surely an expression of The Old Man's. Had I stumbled on a great secret? Was this, in truth, The Old Man himself? If so, I should be able to find corroborative evidence here, now. Presently I calmed myself, but took a keener interest. If he should spit on the cat and do it naturally, as born of long practice, I would be convinced. Idly I took down a volume of *QST* and thumbed through the pages until I came to an Old Man story. No penciled notation. No particular evidence of the book having been opened here more than anywhere else. I was at a loss. And he didn't spit on the cat.

How I craved to look at his junk pile in the cellar. Would "Old Betsy," the famous spark gap, be there? How about the chemical rectifier with the mason jars? Hardly hearing what he was saying, I finally decided to ask him point-blank if he were The Old Man himself.

"You know," said I, trying to be nonchalant and at ease, "you might almost be The Old Man of amateur radio. You've heard of him, of course. Why, I'd —"

"Say, son," he interrupted with a twinkle in his eye, "I've been accused of that before. What's more, I get a kick out of having you young squirts popping in on me and taking me for The Old Man. Maybe I am and maybe not. I greatly admire the old duffer, though I think he's been layin' down on the job lately. Been thinking I would write to that feller Warner some day and give him a piece of my mind about what this game is a-comin' to. Even if I was The Old Man, maybe I couldn't prove it if I wanted to! No, son, you got a bum steer. I switched into this game from train dispatchin' on the U. and U. Here, try some of mine — hain't changed brands in forty years. Say, I've something here you don't see in every ham layout!"

He pulled back a curtain from a case against the wall and disclosed row after row of Crow-foot batteries.

"Had to put a brace downstairs under 'em. Use 'em to give me pure d.c. for things I monkey with. Got a little crystal rig over to a feller's down the road a piece. He's tryin' it out. Cut and ground the crystal myself. Took three months, but was worth it. Can't keep track of all the new tubes and don't try to, either."

I was too confused to know what to think. Finally, I decided that I didn't want to know whether he was The Old Man or not. I hoped he wasn't. We stayed up till eleven and then turned in. He was not up when I had breakfast and I drove away without seeing him again. As I drove out of the yard, a sudden gust of wind whirled some leaves and a bit of paper into my car. The paper was an opened but empty envelope bearing the West Hartford postmark! I wonder.

## Still More Tubes

SINCE the tube announcements in last *QST* information has been released on six more types. One of these, the Type 1, is a small half-wave mercury vapor rectifier with an indirectly-heated cathode. The Eveready ER-1, which was described in March *QST*, is not the same as the Type 1 described here since it is a vacuum-type rectifier. The difference should be kept in mind if a "1" tube is to be purchased:

The ratings on the mercury-vapor Type 1 are as follows:

|  |            |
|--|------------|
| Heater voltage .....                   | 6.3 volts  |
| Heater current .....                   | 0.3 amp.   |
| Max. a.c. plate voltage (r.m.s.) ..... | 350 volts  |
| Max. peak inverse voltage .....        | 1000 volts |
| Max. d.c. output .....                 | 50 ma.     |
| Max. peak plate current .....          | 400 ma.    |

The tube is primarily intended for automobile receiver power supplies. The usual precautions should be taken as to shielding and r.f. suppression to prevent rectifier hash when mercury-vapor rectifiers are used in receiver power supplies.

### THE 2A7 AND 6A7

The 2A7 and 6A7 carry the imposing title of "pentagrid converters" meaning, for one thing, that these types are five-grid tubes. The two tubes are identical in characteristics with the exception of the heaters, the 2A7 having a 2.5-volt heater taking 0.8 amp., and the 6A7 having the 6.3-volt, 0.3-amp. heater. This type of tube is used as a combined oscillator and detector or "mixer" for superhet receivers.

The construction of the 2A7 is rather interesting. There is a regular control grid next to the cathode, and next in line is a pair of wires which look like ordinary grid supports but which constitute the No. 2 grid. The No. 1 and No. 2 grids form the grid and plate, respectively, of a triode oscillator. The No. 3 grid acts as a screen between the oscillator portion of the tube and the detector

(Continued on page 88)





### Link Coupling

MANY methods have been devised for coupling single-ended exciting amplifiers or oscillators to push-pull amplifiers. Fig. 1 shows one scheme for this purpose used by G. R. Boardman, Jr., W8ME. Besides taking care of the coupling difficulties, it makes it possible for the exciter and push-pull amplifier to be located at some distance from each other, although the tuning apparatus for both stages can be placed close to the respective tubes.

The coupling loop is simply a turn or two of wire closely coupled to the tank coil at a point of low r.f. potential. Couple to the end opposite the plate on a single-ended amplifier, and at the center

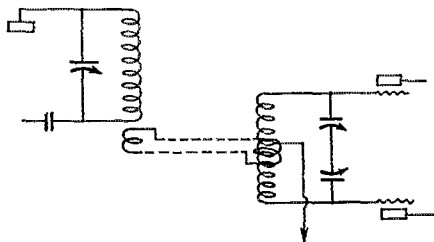

FIG. 1.

of the tank coil on a push-pull stage. This minimizes capacity coupling. The degree of coupling depends upon the relative sizes of the tank and coupling coils as well as the separation between them. The optimum coupling for maximum power transfer can be readily ascertained after a little experimenting. The transmission line can be any convenient length — several feet if necessary — without appreciable loss of power.

### Minimizing Frequency Drift

The information in the following letter from Lt. J. B. Dow, originator of the electron-coupled oscillator, undoubtedly will be of interest to those who want to eliminate as much as possible the effects of temperature in oscillators for frequency meters, receivers, etc.:

"One of the most troublesome causes of frequency drift in any oscillator assembly is due to the effect of changes in temperature. Changes in temperature cause expansion and contraction which alter the amount of capacity and inductance in circuit. By the use of materials having a

low temperature coefficient of expansion these effects may be reduced; however, in the usual forms of construction where aluminum shields, copper coils, conventional condenser designs and commonly used insulating materials are employed, the temperature coefficient of frequency of the circuit assembly cannot be depended upon to be less than 0.005 per cent per degree Centigrade unless by intent or accident the design is such that many of the contributory effects cancel one another.

"In designing oscillators with a view to reducing the effects mentioned, it has been found helpful to mount the entire oscillator assembly upon a single heavy sub-base of metal or insulating material and to fasten the sub-base at three points only, elevating it at these points so as to clear the neighboring shielding. The three points will be the vertices of a triangle. Such a mounting eliminates much of the bending of the sub-base that would take place were it held in position, say, at four points, and any distortion of the surrounding shielding acts in most cases merely to rotate the sub-base about an axis formed by one side of the triangle, without straining or disturbing the relative positions of the various electrical parts which may be mounted upon the sub-base.

"The single-sub-base mounting also overcomes much of the trouble which is caused by expansion when parts of a precision oscillator are mounted upon two or more sides of a shielding compartment.

"Large panels as a rule distort more than do small ones and when large panels are employed, as in receivers, it is very desirable that the oscillator variable condensers, if mounted upon a sub-base, be not rigidly connected by shafts to the front panel as such an arrangement is almost sure to cause an appreciable frequency change whenever a sudden change in ambient temperature takes place. Many forms of flexible shaft-couplings are available or may be devised to overcome this trouble when such a design is dictated by the nature of the dial or assembly."

### Feedback Prevention

Here is a point which might prove of interest to readers of the Experimenters' Section. It concerns feedback in condenser microphone amplifiers.

A persistent case was cured completely by the addition of a choke and a large dry electrolytic condenser. The modulator unit consists of a

condenser mike with a 56 tube in the head amplifier, followed by another 56, then a 46 driver amplifier and finally a pair of 46's, Class B. All

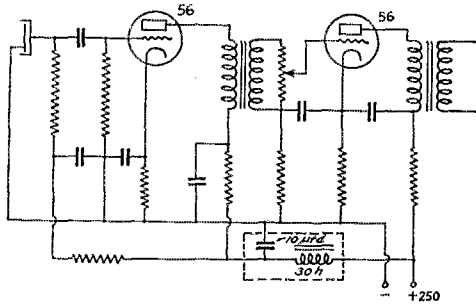

FIG. 2.

the grid returns were very carefully filtered and the plate returns by-passed. However, when the gain control was tuned up the unit would always go into oscillation. The cure consists of the choke and condenser connected as shown in Fig. 2.

— Roy Usher, VE4EA

### A Pinch-Hitting Neutralizing Stunt

It is not generally known that in circuits with symmetrical input and output (push-pull) neutralizing may be accomplished with a single

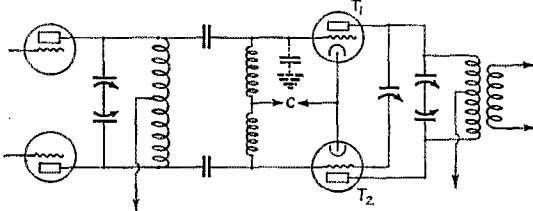

FIG. 3.

condenser, as shown in Fig. 3. Inspection of the diagram will show that T1 is grid-neutralized, while T2 is plate-neutralized. Since this slightly unbalances the input, it may be necessary to compensate for the unbalance by shifting the grid center-tap (or plate tap of the preceding stage), or by adding a small capacity to the side of the input circuit as shown by the dotted lines.

This stunt saved the day when only a single neutralizing condenser was available for an experimental push-pull amplifier.

— Frank J. Burris, W9EBG

### A Hint for Reducing Noise Level

Sometimes it is possible to make relatively tremendous improvements in performance without spending a cent for additional equipment but just by using one's head. Here is a letter from J. D. Blitch, W4IS, which nicely illustrates the

point, and which incidentally may prove to be of assistance to 'phone operators who are having trouble with hum in speech amplifiers:

"An a.c. amplifier was designed to follow a battery operated pre-amplifier actuated by a condenser mike. The amplifier was transformer coupled and used a 27 in the first stage and two 27's in push-pull in the second stage, high grade transformers being used. It was assembled on an iron chassis, and chokes, transformers, etc. were in iron cases. The filter consisted of an initial 10-henry choke followed by an 8-mike electrolytic, a 30-henry choke, and another 8 mikes as the termination. A 25,000-ohm filter resistor was inserted in series with the lead to the first audio B plus and a low hum level predicted.

"Measurements of hum were made with a rectifier voltmeter and 10,000 ohms connected to the two plates of the push-pull tubes. The initial measurements showed  $1\frac{3}{4}$  volts as the hum level and as this amplifier was to be followed by another of some considerable gain, the result was not good enough. A little experiment showed that the principal hum was developed in the first stage and amplified through. And further, a listening test indicated that 60 cycles was the offending frequency. When the input (to the first tube) transformer was moved away from the power transformer the hum decreased but was still persistent to some extent at a distance of two feet. When it was returned to its original position near the power transformer it was found that it would actually take one quarter of an inch of iron (thickness) to lower the hum level to the value obtained by isolation. This iron was used for magnetic shielding around the audio transformer, of course.

"About this time it was noticed that if the audio transformer was revolved slowly the hum level indicated by the needle would sink slowly to a value below that obtained by isolation or shielding and then rise again as the optimum position was passed. The point is that the mutual induction between power transformer and audio transformer can be made zero or any value desired by suitable positioning.

"To cut my story short the troublesome induction was utilized to buck the residual hum to a value several times lower than could be obtained by isolation of the transformer. To my surprise I obtained a total hum and noise level of one-tenth volt across the plates when the gain control was set at maximum and the condenser mike and preamp connected to the input, in a quiet, midnight room! Compare this with the output level of 80-90 volts when the mike is whistled at rather faintly from across the room. The ratio of the power of the noise level to the power at full output is thus ridiculously low."

## Revamping the Old Majestic "B" Supply

"B" eliminators using the familiar Raytheon gaseous type of rectifier are notoriously poor from the standpoint of voltage regulation. However, the regulation of any of these eliminators may be greatly improved and the voltage out-

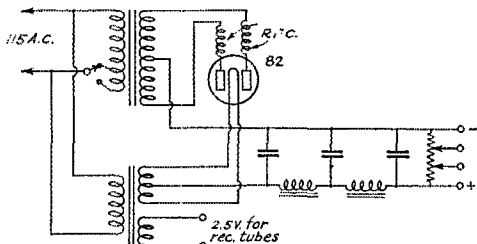

FIG. 4 — THE REVAMPED MAJESTIC SUPER B

put materially increased by the simple installation of the now popular 82 mercury vapor tube in place of the old gaseous tube. In several Majestic "Super-B" eliminators that we have changed over here, the results have more than justified the small amount of trouble it took. After the cut over, it is possible to work one of these outfits at a load of about 40 mils and still get a voltage in excess of 300 volts:

First, filament supply for the 82 tube must be provided. Any of the numerous small 2½-volt filament transformers handled by *QST* advertisers will do very nicely. On some of these it is possible to add another 2½-volt winding to handle the receiver heaters and filaments. This will then provide all power supply for a receiver from a single compact unit.

The filament transformer can be mounted down in the eliminator beside the rectifier tube. In some cases, it may be necessary to move the tube socket over to make a little more room for the transformer. It will also be necessary to remove the wiring from the tube socket and change the two high-voltage transformer leads from the filament terminals to the plate and grid terminals respectively. Small r.f. chokes of the mail order variety, costing about 15 cents, should be inserted in each of the rectifier plate leads to reduce or eliminate the mush that is one of the concomitant annoyances experienced with mercury tubes.

It may be that the eliminator condensers will not stand the greatly increased voltage now obtainable. In case they break down, they should be replaced with the square, dry electrolytic condensers that are now obtainable in cardboard containers. It would be a good plan to replace the condensers from the start as it is possible to get higher capacity from the electrolytic units and much better filtering and regulation. In four eliminators of this type that I have changed over,

two suffered breakdown of the original condensers but now that these have been replaced with the new electrolytic condensers, they are the best of the lot.

Fig. 4 is a rough schematic of the essential changes to be made.

— B. P. Hansen, W9JNV

## Silent Keys

It is with deep regret that we record the passing of these amateurs:

Edward F. Anaspach, W8BBR, Cincinnati, Ohio.

Dr. Jose de Azevedo, PY2AU, São Paulo, Brazil.

Donald R. Fincato, W8BJJ, Mt. Carmel, Pa.

Edward Haines, Ex-W3DD, Cumberland, Md.

Corrille E. Jones, W8FLF, Dexter, N. Y.

William Lohr, Topeka, Kans.

Howard L. Middaugh, Ex-W8CNT-W1AEX, Fredonia, N. Y.

Ralph J. Rieman, W8CHG, Buffalo, N. Y.

Merle S. Rusk, W3BYE, Baltimore, Md.

Harold W. Westfield, Ex-W8HW, Wilkes-Barre, Pa.

William L. Williams, W9GQG, Brunswick, Mo.

## Strays

And then there's the ham who informed W6CSV that he couldn't QSP because he hadn't handled a message in four years and didn't want to break his record! At least he was honest about his reason.

A noisy volume control resistor can be cured by packing it full of graphite grease.

— W1CAMZ

W2BTO suggests putting your return address on the address side of QSL cards so that if the card cannot be delivered it will be returned. Inquiry at his local postoffice developed the fact that cards which could not be delivered because of incomplete address (there are lots like that) were thrown away. This may not be general practice, but putting your return address where it is sure to be seen will prevent its occurring.

W7BKE suggests using wooden cut-out blocks (obtainable in the children's departments of most ten-cent stores) for making call signs. Attractive signs can be made up in various ways. Paint helps, too.

# Checking the Performance of the Superheterodyne First Detector

By Alfred L. Chaney, W6AIA\*

FROM a survey of the multitude of superheterodyne circuits now available, one gathers the impression that the first detector-oscillator combination is still shrouded in considerable mystery, and even protected by considerable misinformation. Audio detectors have by now succumbed pretty thoroughly to rules and regulations, and the gain, distortion, etc. for the various tubes can be measured and calculated to a nicety.

What a young superheterodyne designer ought to know about his first detector might be the answers to the following questions:

Which tube makes the "best" first detector? How much r.f. gain is contributed by the detector tube? What factors influence this r.f. gain? They

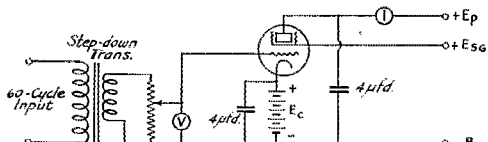

FIG. 1—THE EXPERIMENTAL CIRCUIT FOR MEASURING FIRST DETECTOR PERFORMANCE

may be answered by following to their bitter ending the methods by which audio detectors have been analyzed and measured.

To begin with, one may visualize the combination of the oscillator voltage and the incoming signal voltage as being very similar to the process of modulation. For simplicity's sake, suppose that the incoming signal is an unmodulated carrier and, as is usually the case, that it is very much smaller in magnitude than the voltage supplied by the local oscillator. These two voltages are then applied to the input of the detector tube and in its plate circuit there appears a voltage of the difference or intermediate frequency.

Pursuing the analogy between modulation and heterodyne detection, a modulated carrier wave may be thought of either as a sine wave whose amplitude varies at the modulation frequency, or as resolved into three different frequencies known conventionally as the carrier, the inferior side band and the superior side band. Using the former terminology, the modulation frequency resulting from heterodyning in the first detector becomes the intermediate frequency and, since the signal voltage is small, the amplitude or degree of modulation is likewise small. In terms of side bands, the

intermediate frequency is seen to be analogous to the lower side band.

For the sake of definiteness, let us label the signal, or input voltage, as  $E_i$ , the oscillator voltage as  $E_s$ , and the intermediate frequency or output voltage of the detector as  $E_o$ . The degree of modulation is accordingly  $\frac{E_i}{E_s}$ , and the gain of the detector stage is  $\frac{E_o}{E_i}$ .

If one applies to the input circuit of the detector tube a known a.c. voltage, and increases and decreases this voltage slightly, the process is analogous to the oscillator voltage being increased and decreased by the signal voltage. To obtain the output voltage at the intermediate frequency, it is only necessary to know the change in plate current and to multiply it by the effective resistance in the plate load circuit. For convenience sake, the a.c. voltage representing the oscillator may be of 60-cycle frequency, and the plate current changes may be followed on a d.c. milliammeter. The rest of the process is graphical.

A suitable circuit is shown in Fig. 1. The plate and screen-grid voltages may be obtained from a "B" eliminator and the grid bias from batteries. For measurements using automatic bias, a resistor in the cathode circuit replaces the "C" battery. The by-pass condensers should be large enough so that they offer negligible impedance to 60 cycles. The plate current is measured for various a.c. voltages applied in the grid circuit,

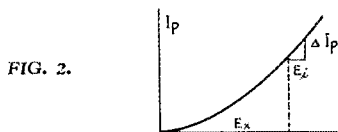

FIG. 2.

ranging from zero up to values as large as possible without allowing the grid to become positive at any part of the cycle. The limit of the peak a.c. voltage is accordingly the grid bias of the tube.<sup>1</sup> These values of plate current are then plotted against the corresponding a.c. grid voltages. A typical curve is shown in Fig. 2. For a given oscillator voltage  $E_s$ , the effect of the modulating input signal  $E_i$  is to increase and decrease slightly

<sup>1</sup> If an ordinary a.c. voltmeter is used to measure the a.c. input voltage, its r.m.s. readings should be multiplied by 1.41 to give the peak values. This assumes that the a.c. wave form is sinusoidal, which usually will be the case. — Editor.

\* 663 Corwin Avenue, Glendale, California.

the total voltage, producing a corresponding change of plate current,  $\Delta I_p$ . The output voltage at intermediate frequency is then  $\Delta I_p \times R_{(load)}$ .  $\frac{E_o}{E_i}$ .

As stated previously, the detector gain is  $\frac{\Delta I_p}{E_i} \times R_i$ . The fraction  $\frac{\Delta I_p}{E_i}$  is seen from the graph to be the slope of the curve at that point. Hence the detector gain is the slope of the curve (for any given oscillator voltage) multiplied by the load resistance. It should be noted that this gain is independent of the size of the signal voltage, provided it remains small in comparison with the oscillator voltage.

This simple derivation at once enables one to select the best conditions for detection, and also the most suitable tube. Actual curves on the new screen grid tubes Types 57 and 58, as well as on the Type 24, are shown in Fig. 3. The plate current is taken as from zero with no oscillator voltage, since it is only the increase in plate current which

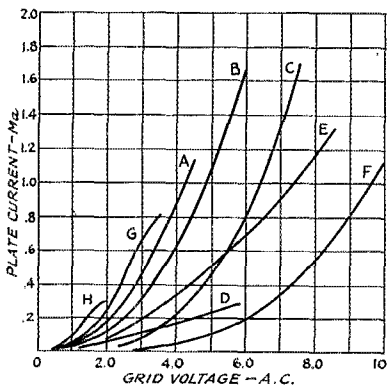

FIG. 3 — COMPARATIVE PERFORMANCE CURVES

| Curve | Tube | $E_p$ | $E_{sg}$ | $E_o$                       |
|-------|------|-------|----------|-----------------------------|
| A     | 57   | 200   | 67.5     | -4.5                        |
| B     | 57   | 200   | 90       | -6                          |
| C     | 57   | 200   | 90       | -7.5                        |
| D     | 57   | 200   | 67.5     | 10,000-ohm cathode resistor |
| E     | 24   | 200   | 90       | -8.5                        |
| F     | 58   | 200   | 90       | -10                         |
| G     | 57   | 200   | 45       | -3.5                        |
| H     | 57   | 200   | 22.5     | -2                          |

is significant. Conclusions may be drawn immediately from these curves. A comparison of fixed bias with automatic or cathode resistance bias is given by curves A and D, both for a 57 tube. The fixed bias gives a gain approximately ten times as great as cathode resistor biasing. This is in line with data for tubes used as ordinary audio detectors, though the difference in efficiency is nowhere near so striking in that case.

It is not necessary, of course, to use a battery in order to provide fixed bias. The voltage drop across a resistor in the cathode circuit of other tubes (such as the oscillator, r.f. or i.f. tubes) may be used for biasing purposes, as may be the drop in a voltage divider across the "B" supply. A

combination of such an arrangement together with a certain amount of automatic bias is shown in the Single-Signal superhet (*QST*, Aug., 1932). The gain in such cases will be intermediate between that obtained with absolutely fixed bias and with only automatic biasing.

The 57 tube turns out to be considerably more sensitive than the 58 tube as a first detector, but

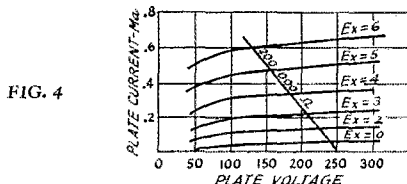

FIG. 4

the 58 tube is seen to be less critical as regards the optimum oscillator voltage. For either tube the screen-grid and biasing voltages are not exceedingly critical. Curves A, B, and C, for the 57 tube under widely different conditions, all show maximum slopes of the same general magnitude. For very low screen-grid voltages, as in Curves G and H, the sensitivity is somewhat less. This is in contrast with its behavior as an ordinary detector, in which case it is most sensitive to weak signals at low screen-grid voltages. The curves illustrate the fact that for a fixed oscillator voltage (for example, 3 volts) the sensitivity is greater for the lower screen-grid voltages. The greatest sensitivity, however, is obtained not by decreasing the screen-grid voltage but by increasing the oscillator voltage.

The most important single factor is the oscillator voltage. The slope of the curve, and hence the gain, increases rapidly up to the point where the peak oscillator voltage becomes equal to the bias voltage. Beyond this point the gain would drop off because of excessive damping caused by grid current. The curves of Fig. 3 may be used to give an approximate idea of the actual oscillator voltage in a given setup. By using a milliammeter in the plate circuit of the first detector, the change in plate current which occurs when the oscillator is started and stopped enables one to determine when the oscillator is supplying the correct voltage. This makes the first detector act as its own vacuum tube voltmeter.

These curves show that with the new tubes it is possible to get a really substantial amount of gain from the detector tube itself. The maximum slope of curves B or C multiplied by a plate load of 200,000 ohms gives a gain of 130. Used as a straight amplifier with the same load in the plate circuit, the corresponding gain would be 210.

#### APPENDIX

In order to obtain as simple a method as possible for testing detectors, certain assumptions

(Continued on page 72)



# STRAYS



Hams building temperature-control boxes for crystals will do well to look up dealers in tropical fish supplies, who have some reasonably-priced thermostats which are sensitive and will handle about 500 watts without a relay. W1BKG has one (it cost \$1.50) which holds an uninsulated aquarium to better than one degree Fahrenheit. Ought to be good on a crystal oven.

Mounting the motor-generator unit, which is staging an apparent come-back with the Class B phone men, can be made simple and practical by using the coil-mounting units used by manufacturers of electrical refrigerators. These mountings are obtainable from the larger manufacturers for about \$3.00 per set of four, and will completely eliminate m.g. noise.

— W9CRY-DDM

## ODE TO A NEW RIG

All day long he sits to figure  
On what he'll have in his wireless jigger.  
He'll have to buy, much to his sorrow,  
He's getting so he hates to borrow.  
He'd like his parts all of the best —  
A little different from the rest  
Of homemade junk around the town  
That's every minute breaking down.  
In feverish glee he scans each ad  
And covers the pages of half a pad  
With a list of expensive this and that  
(I wonder — will I get an Easter hat?).  
A 203-A he's going to buy  
And a new transformer that'd knock your eye;  
Condensers and whatnot are forthcoming, too,  
This wonderful rig will be shiny and new.  
My only fond wish is that everything perks  
Or I'll put an axe in the whole blooming works!

— Mrs. W3ETH

We recently saw some rather neat little name-plates. They are made of strip aluminum  $\frac{3}{8}$ " wide and in various lengths. The aluminum has been blackened by a chemical process but the raised letters are clean metal and contrast with the black background. They will be useful for purposes such as panel markings. They are being sold by Blan, the Radio Man.

Hams having difficulty in obtaining square brass rod to use as corner pieces in building shield boxes will be interested to know that it can be obtained already drilled and tapped for 6-32 screws from R. H. Lynch, W6DZI, 970 Camulos St., Los Angeles. W6DZI can supply it in various

lengths from one inch to four feet, appropriately tapped and furnished with screws.

In connection with velocity microphones, W4IS writes that the aluminum foil in which Eastman Autographic Films are wrapped is  $\frac{1}{2}$  mil thick and works to perfection in this type of mike.

Copper or aluminum cans salvaged from defunct electrolytic condensers of the two- or three-section type can be used to make excellent shields for coils.

— EEW9ERY

W2DPP uses a cellophane cover to keep dust off his breadboard transmitter. The cellophane sheets are glued to a frame made of light wood and the whole works sits on the table, covering the set. It can be lifted off easily when adjustments are to be made. Not a bad idea.

W6ASC has two sets of license plates, one with the number 7D73 and the other 7D88. To top it off, when he moved to San Francisco not long ago they gave him the telephone number Graystone 7388!

W2LG says that the bread tins sold by Kresge, Grant and other stores for about twenty cents are FB for monitor cans. Cost of parts is certainly no excuse for not having a monitor these days.

Speaking of miles-per-watt records, W9IDW in Yankton, S. D., worked W8BOW in Wheeling, W. Va., with 45 volts and 6 mils on a 10 on the 80-meter band, which figures out to more than 3000 miles per watt. The actual distance is about 900 miles — quite a respectable achievement.

W9DPE uses a pair of No. 10 weather-proofed wires twisted together as Zepp feeders. The wires are cut to the same length as ordinary spaced feeders and tune just as sharply. The whole system is much lighter than when spacers are used, and frequency change with swinging in a strong wind is eliminated.

"Ur PDC hr."

"Watsat?"

"Your note sounds like Pigs Devouring Corn!"

— W9FO

"Metallic X" or "cold solder" is handy for fixing tubes on which the bases have come loose. Run it in at the junction of the base and envelope and allow it to set.

— W8WO

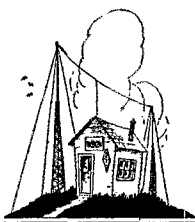

# Amateur Radio STATIONS

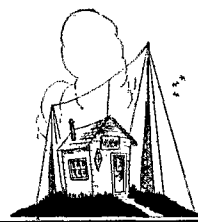

## W8AFM, Lockport, N. Y.

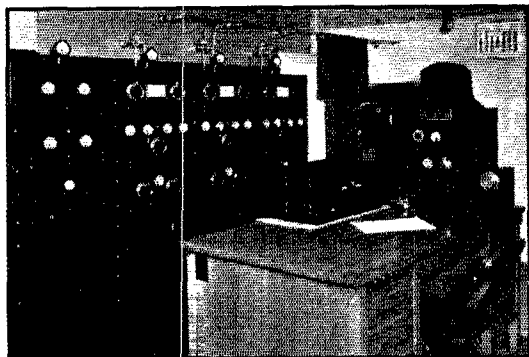

W8AFM  
Separate transmitter for each band, c.w. and 'phone.

W8AFM is a station that has been periodically rebuilt and modernized at intervals during years past, but is now in permanent shape. As it stands it is the type of outfit that most hams dream about, but which few ever achieve. There are three separate transmitters, one for each of the three most popular bands, all run from a common power supply and excited from a single crystal unit. Both 'phone and c.w. can be used. T. W. Connette, of Carlisle Gardens, Lockport, N. Y., is the owner.

In describing W8AFM, the proper place to start is at the operating desk, because it is on this desk that the exciter unit is located. The transmitter control panel at the extreme right-hand end of the desk contains, in addition to the controls for filament and plate voltages on the transmitters and modulating equipment, the crystal oscillator and a doubler. Any one of ten crystals in the 1750-kc. region, all temperature controlled, is available at the turn of a selector switch. The tank circuit of the oscillator, which uses a 47 tube, is tuned only roughly by means of taps on the tank coil. For c.w. keying, this coil is detuned through a .001- $\mu$ f. fixed condenser, thus reducing the output to zero, and allowing break-in operation on c.w. The power output on all transmitters can be controlled by a rheostat which adjusts the plate voltage on the oscillator. The oscillator feeds into a second 47 used as a doubler, the out-

put from this stage being run to the transmitters through a transmission line which goes under the floor.

There are four main divisions in the transmitter proper. The one occupying the first vertical section at the left in the photograph is the modulator. It contains a Class B modulator using a pair of 203-A tubes, furnished with a 1000-volt power supply which has extremely good regulation. To drive the Class B stage there is a speech amplifier consisting of two single-ended stages using 27's and a power stage with two 50's in push-pull. A 500-volt supply takes care of these four tubes.

The next three vertical units are the 7-, 3.5- and 14-mc. transmitters, respectively. The general construction in each case is similar.

There is a top panel containing the output tank circuit and the antenna coupling and tuning apparatus. The second panel from the top contains the output tubes and their exciters. The 7-mc. transmitter has a pair of 860's in push-pull, while the other two each have a pair of 852's. In all three cases the exciting amplifier is a pair of 10's in push-pull. The meters on each of these panels measure the plate current and filament voltages for the two stages. The third panel from the top contains the buffers or doublers required

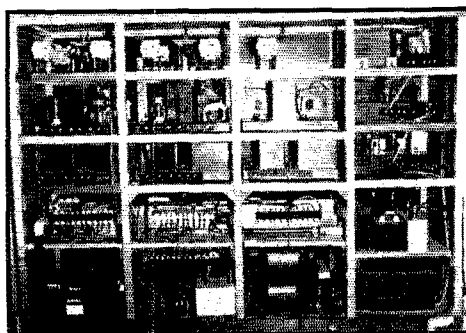

A VIEW BEHIND THE TRANSMITTER RACK  
Showing the unit construction of the transmitters. The 7-mc. transmitter (third from the left) was not quite completed when this photograph was taken and shows a little more clearly how each shelf is built as one removable piece.

by the frequency on which the output circuit works. Each of the panels is built as a unit and can be removed from the front for repairs or alterations without disturbing the rest of the outfit simply by disconnecting the terminals at the rear.

The lower part of the frame is occupied by the power supply equipment, which includes a 2000-volt supply with 872 rectifiers, two 600-volt supplies with 81's, and a "C" bias supply with an 80. A rod coming through the front of each of the vertical sections works a 12-blade switch by means of which the power supplies can be connected to any of the three transmitters. Auxiliary switches on the lower panel break the primaries of the power transformers so that any

transformer can be turned on or off during tests. All high-voltage circuits and transformer primaries are fused.

The antenna feeders run in from the right above the main transmitter. Either of the three transmitters can be connected to the feeders by means of curved rods which fit into switch jaws appropriately placed. The antenna is a center-fed 7-mc. Hertz, 33 feet on each side, and the feeders are approximately 50 feet long.

A condenser microphone is visible on the operating desk beside the control panel. A three-stage resistance-coupled amplifier using 864 tubes is built into it. Batteries for the microphone and

*(Continued on page 70)*

### W8CMA, Mt. Eaton, Ohio

THE accompanying photograph is a view of the 'phone station signing W8CMA, owned by Wayne E. Schaffter, of Mt. Eaton, Ohio. The transmitter is crystal-controlled, using a 210 oscillator, 210 buffer and two DeForest 510's in the modulated amplifier, which is operated with 600 volts on the plate. Two 845's in parallel are used in the modulator, fed by a speech-amplifier consisting of a 227 resistance-coupled, 227 transformer coupled and a 245, the latter tube transformer-coupled to the grids of the modulators. A low-voltage power supply with 281 rectifiers for the oscillator and buffer, and a high-voltage supply with 866's for the modulators and modulated amplifier, comprise the power equipment. Each tube in the transmitter has its own filament transformer, and the plate current of each tube is read separately, the excitation being adjusted so that the two tubes in the modulated amplifier draw the same current.



The receiver is an eleven-tube broadcast superhet with a two-tube converter for high frequencies. There is also a dynatron frequency meter and a listening monitor. The antenna is a Zepp.

W8CMA has worked all districts with this outfit with excellent reports.



### W6ADK, San Francisco, Calif.

THIS station is owned by D. M. Fisher, and is located at 1422-A Twenty-first Ave., San Francisco. The transmitter is a three-tube crys-

tal set using a 247 oscillator with 300 volts on the plate, a 247 buffer at 450 volts, and a 20 3-A final amplifier with 1100 volts. Four crystals are used, all with fundamental frequencies in the 7000-kc. band, with temperature control. For 14-mc. operation the 203-A is used as a doubler. The receiver is a Hammarlund Comet Pro.

W6ADK has been on the air only a little over a year, and during that time has had several varieties of transmitters going, finally ending up with the crystal outfit, which has been the most satisfactory of all of them. Plenty of DX has been worked.

### Strays

W9FUR has painted his transmitter a Kil-larney Green in the hope of working Ireland!



# THE COMMUNICATIONS DEPARTMENT



F. E. Handy, Communications Manager  
E. L. Battey, Assistant Communications Manager

READ the Section reports, and you will share with me, a considerable pride in the fact that practically *every* Section boasts of operators that handled "earthquake traffic." Not merely a handful of amateurs stood ready to cooperate in this emergency; the whole amateur fraternity participated. The 'quake gives L. A. a record total in excess of 36,000 messages, and in spite of the fact that the season's peak had passed, the national message figure smashes all records in A. R. R. L. history. Congrats to each and every operator who helped in this constructive service.

The mail is increasingly filled with comments about "pre-historic" signals, 500 cycles, and a.c. notes in c.w. territory, and use of v.t. and buzzer modulation, music transmission, and monopolization of frequencies in the 'phone bands. These things, and some general misuse of high power, about which I may have more to say later, are clearly *abuses* of the individual right to operate. In some cases amateurs "get by" with a 500-cycle power supply, which but for maladjustment and feed-back may not be a technical violation of the regulations (under the example of Par. 382 of the F. R. C. regulations) . . . but from every ethical and moral standpoint this is nothing more or less than plain unadulterated selfishness. The result of such operating is to make amateur radio less enjoyable for all. If an operator can equip for high-power work, it is a fact that he can afford proper power equipment to go with the set. If not, he should plan a moderately powered set with a simple but adequate, and now relatively inexpensive brute force filter.

Abuses often create their own remedies. I feel that the time is coming shortly when the League, mindful of the enjoyment and welfare of *all* amateurs, must act to restrict and curb the selfish few who *so* abuse regulations. By a simple act of "deleting" the F. R. C. could readily change Par. 382 to prohibit use of unrectified a.c. on even the amplifier stages of transmitters; to require "adequate" filtering throughout the power supply equipment. Further restrictions should apply only to the 1715-2000-, 3500-4000-, 7000-7300-, and 14,000-14,400-ke. bands of course. If you are for (or against) such further restriction it is suggested that you drop a letter or postal to your Director expressing your views fully; the A. R. R. L. Board, nationally representative, determines the League's policy and action in all such important matters.

Speaking of rotten signals, want to do yourself and other hams a good turn? When operating your station don't pass up an opportunity to improve operating conditions when you can do so, tactfully. It's a funny thing, how fellows with rotten notes never (or is it seldom) read an article like GG's "How to Cure Rotten Sigs" (page 13, April Quist). Do your part, anyway, and the fellows you help will appreciate it. Tell any of the gang with poor signals just where they can find the dope.

The new ultra-selective receivers are coming into wide use. Best of all, they put a premium on really good notes, signals with frequency stability and all the "push" on one

frequency where it belongs (not wasted in modulation sid bands). One of the keen new receivers will increase your enjoyment in ham radio — they even cure key click trouble between locals. *The bum notes will disappear* as all stations get equipped with really selective receivers. A "spread-out" signal with frequency wabulation (no zero beat obtainable) will stutter back and forth across the narrow admittance band of the good receiver and be received but poorly at best. The low power station with a good signal, and the energy all where it belongs, will be received (actually) with greater audibility and reliability. This day of superior receivers is already dawning. When it bursts on the consciences of operators generally, additional power supply filtering and frequency stabilizing will be undertaken speedily. Watch it! And make your transmitter live up to the new receiving standards . . . roll up some new DX.

Counting the number of individual amateur items that fill the Section reports, I find only 60% of the gang reporting traffic. The other 40% are 'phone ops, experimenters, DXers, old-timers, rag-chewers, etc. . . . about 3000 live-wire hams in all. If you are a live ham, whether on the air new today brasspounding, or behind a mike in a ham station for the last ten years, don't forget that your SCM (see ad page 5) welcomes your dope for his report (16th every month), and you don't even have to be a Member you know. It is our aim to make the Section reports a live "directory" of all the active stations on the air and on the job, a directory full of news and facts about every amateur that can be consulted at any time for the currently active stations at any point in the U. S. A. and Canada. So remember your SCM on the 16th . . . a postal card will do the job.

— F. E. H.

## Accuracy

EVERY once in awhile we find an operator, when taking traffic, who *always* comes back with "R" at the end of each message. That is fine business if he gets the copy perfect, but there is always the danger that this same operator may be guessing and filling gaps caused by fading and QRM.

A short time ago, I gave a message to an operator who I am sure could receive as fast as anyone can send with a straight key. A week later I heard this same fellow relaying this message. The delay, however, proved lucky for the one to whom the message was sent. The message read "leaving for Chico at 12 o'clock." The operator, because of a guess, had him leaving for Chicago. Chico and Chicago are a long way apart, one in California, the other in Illinois. That fellow's estimate of amateur radio went down considerably due to operator's carelessness and inaccuracy — not to mention an uncalled-for delay.

Another example (from Tit-Bits). A Scotch clergyman, noted for his thrifty habits, sent a telegram to a parishioner on her wedding day. The message read "John iv. 18." On looking up the text the girl was horrified at these lines: "For thou hast had five husbands; And he whom thou now hast is not thy husband."

After they had restored the young woman to consciousness, inquiry was made at the telegraph office and it was found that the operator had omitted the letter or numeral indicating the first epistle John I iv. 18 reads: "There is no fear in Love, but perfect love casteth out fear."

So let's remember that Accuracy is after all of major importance. Speed is of importance, too, but only after all possible precautions have been observed by both operators to avoid the possibility of error. ACCURACY FIRST is a good slogan. — WGDVE.

## On Reporting

By C. R. Cannady, W9EYG\*

WITH more than 32,000 amateur station operators in the United States we naturally have a diversion of interests. There are those whose chief interest lies in radio-telephony, brass pounding, rag chewing and DXing. With few exceptions, however, every actively operated amateur station handles at least one message per month. This message may be originated or delivered or have been relayed, which would have made the relaying station a total of two. It is such cases wherein a great loss in reports of traffic is experienced.

If an operator handles 100 or 200 messages in a month, he will report. Those who handle from one to thirty messages per month feel that their reports would not change the status of their section or of the whole country and so neglect to report to the Section Communications Manager of their section. Such a feeling is incorrect and should be discouraged. Often a single additional station reporting traffic though that traffic be ONLY ONE message would change the relative standings of the various sections and divisions considerably. Yes, it might even turn the standings bottom side up! More than once in the past, experience has shown, it would have made our section the LEADER instead of second or third in comparison with other sections. Think what this would mean: A BANNER instead of a has run! GLORY instead of try again next time! A feeling of having accomplished something worth while instead of having fought and lost!

Help your Section Communications Manager. Drop him a card on the sixteenth of each month and tell him the results of your month's work, DX, various records, schedules, traffic, if any, etc. He is interested in all of this and your reports will be heartily welcomed. They will make inactive stations in your section take notice! Stations in this particular section who have been on the air for as long as EIGHT years yet never have reported their activity have been attracted in just this way. The results are most surprising! Your S.C.M. wants to hear from every ham who is on the air, whatever his special interest, and whether he is an A.R.R.L. member or not.

Your report will be of interest to many other stations and will also bring in their reports of traffic and other activity. In this manner a rapid climb will be noted by both your section and division until both are leading the entire A.R.R.L. Field Organization. Think it over and send in your report the sixteenth of this month and of every month to the Section Communications Manager of your Section, whose address you will find on page 5 of this QST. He will thank you greatly and you will be helping your section and the A.R.R.L. immensely. What SAY, GANG? Thanks!

SOMETHING TO THINK ABOUT!  
"IF ALL HAMS WERE LIKE YOU"

It was a most pleasant experience to have a new amateur — a W9L — make this statement: "If all hams were like you ham radio would be heaven." Such a state-

\* A.R.R.L. Section Communications Manager Missouri, 300 Sixth St., Monett, Mo.

ment naturally makes one begin to wonder! Surely this person had met up with someone who was not very considerate of a new amateur or such a thought would never have entered his mind. Were you that person? Oh, perhaps not with this particular amateur BUT ARE YOU AS CONSIDERATE with a beginner as you might be? Are you patient with him if his apparatus happens to need some adjustment during a QSO? Do you QRS to a speed that he can copy? Do you stop to think that once you were wearing his shoes and that you would have so much appreciated having someone help you out? Do you stop to CONSIDER: THAT there are many things that come as routine duty to you that beginners never heard of? THAT he would gain MUCH if you would just tell him of such? AND THAT his operating procedure and speed would probably be greatly helped? THAT, though you might consider him a lid now, in a comparatively short time he would become a good operator? Don't you think that if you would use just a little more consideration for the other fellow that there would be fewer lids? Did you ever stop to think that the poor operator, who remains poor after being on the air for some time, does so BECAUSE some experienced operator has FAILED to give him the proper attention and care in offering advice and help? THINK it over, gang! "If all hams were like you ham radio would be heaven" — a statement that one could well afford to spend much time to have a beginner make! Considering everything, OM, IF ALL HAMS WERE LIKE YOU HOW WOULD AMATEUR RADIO BE? Give it a thought! Be Honest! See if there is not something, SOMEWAY, and SOMEHOW that you can do to improve things in HAMDOM! REMEMBER there will always be beginners and it is our DUTY to get them started on the right track! You were once a beginner!

## Traffic Briefs

The 3.5-mc. band played an odd trick on W6GXE while he was QSO VE4FD — the contact was going along smoothly when QRM suddenly blotted out VE4FD; the source of the QRM was ZL3DC, who was QSA5 R5 at W6GXE.

The "checkers-by-radio" craze has hit LACONA, N. H. Every night at 7:15 W1EKO, W1CGJ and W1FX get together and play with much enthusiasm. W9DQD, Grand Junction, Colo., is another checker hound and challenges all comers on 3.5, 7 or 14 mc.

Ferd. C. W. Thiede, Hempstead, L. I., N. Y., has held the call "2EC" since the early part of 1913. His first operator's license was issued December 13, 1912. He joined A.R.R.L. in August, 1914. Truly, "an old time ham what am."

With the coming of the "chess by radio" and "checkers by radio" craze we pause to meditate what a boon it would be to the OMM (old married man), if someone would devise a means to play "poker" (etc.) by radio!

Believe-it-or-not, the jig saw puzzle mania has hit ham radio! And with it comes a new QSL card idea. W9GJU (J. G. Riddle, Independence, Kan.) and W8HJN (R. W. Jaderstrom, Jamestown, N. Y.) each recently sent us a jig saw puzzle. Glue your card to a small block of ply-wood and make your own.

W9EXL has had a QSO on each of the well-known amateur bands, 56, 28, 14, 7, 3.5 and 1.7 mc. He wonders if this is a record.

Don't miss it! The Milwaukee Radio Amateurs Club, Inc., will hold its Tenth Annual QSO Party at 6:00 p.m., Saturday, May 13th, at the Hotel Pfister, Milwaukee, Wis. Enough said! Reservations, \$1.75, if made in advance, \$2.00 at door. Everyone welcome. Send reservations to W9ANA, Louis A. Wollaefer, 1606 Martha Washington Drive, Wauwatosa, Wis.

## NX1XL

C. S. Taylor, VE1BV, Stewiacke, N. S., has been keeping regular schedule with NX1XL, Prof. Wm. H. Hobbs, University of Michigan Expedition in Greenland, located at Peary Lodge, Northwest Coast of Greenland, 700 miles north of Upernivik, on about 7300-kc. Several VE's have also been in contact. All amateurs are asked to be on the lookout for NX1XL. The University of Michigan, W8AXZ, is anxious to reestablish schedules with NX1XL; any amateur working NX1XL please advise the operator of this fact.

If you've ever heard SMX and wondered about the QTH, W9AOE reports SMX is assigned to the Swedish Polar Year Expedition located near Nordenskoldsberget on the Spitzbergen.

## C.M.T.C.

Recruiting is now in progress for the 1933 Citizens Military Training Camps. The Signal Corps Section, C.M.T.C., offers much valuable and practical experience and training in radio communication. In past years many radio amateurs have availed themselves of the opportunities offered and have found the work extremely interesting, especially those enrolled in the A.A.R.S. Inquiries regarding this summer's encampments may be addressed to the American Signal Corps Assn., 39 Whitehall Street (Room 811), New York City, or to your local C.M.T.C. authorities.

## 28 MC.

W6BXV did considerable listening and transmitting on 28 mc. during week-ends in February. On the 11th from 1:00 to 3:15 p.m. PST he heard W9DRN, Chicago, QSA4 R6, some fading. On the 12th he again heard and this time worked W9DRN from 10:45 to 11:30 a.m. On February 18th W8IC was heard at W6BXV. W9JHS heard W6BXV, February 11th at 1:15 p.m. CST, QSA4 R6. W6AM is set up for 28 mc. work with a new ½ kw. transmitter, which radiates ½ amp. into 36th harmonic antenna 612 feet long. Reports on all 28 mc. work will be appreciated by A.R.R.L. HQs.

The "QSO Endurance Record" (18 hours of continuous QSO, February 7-8, 1931) held by W6EMA and W6EZP was broken January 28-29, 1932, by W7WV, Vancouver, Wash., and W7HD, Portland, Ore., when they maintained unbroken communication for 20 hours, 2 minutes!! Congratulations, OMs.

An echo of the earthquake! At about 9:30 p.m. on the night of the Los Angeles 'quake W6WQ gave W9ASI four messages. One of these messages, addressed to Kansas City, reached the addressee before the 'quake had been reported to them and they couldn't figure out the text, which read, "Everything OK." Would that all ham messages were handled that promptly!

Fred C. Arnold, Waukegan, Illinois, a post office employee, suggests that all licensed amateurs file with their local P. O. data on their call letters and complete address. This would assist the P. O. authorities greatly in cases where a QSL card or other communication is received addressed only with the call and city (and it might even bring you some DX QSLs, which would otherwise get lost!). Visit your post office to-day.

## PRAIRIE DIVISION

Traffic: VE4MW 115 AC 78 GC 34 FT 12 DK 11 LH 7 LN 5 PP 3.

SASKATCHEWAN — SCM, Wilfred Skaife, VE4EL — Saskatoon holds a hamfest May 24th. Will you be there? First reports from VE4CC, GI, MT, HG, KA, MX and KM. VE4LI is building rack and panel. VE4ND is new ham. VE4GN worked a G2 and K7. VE4FH is on 7 mc. VE4HX has click trouble. VE4GI would like ORS. VE4BB had visits from VE4IE, BN and Ex4HP. Would like to see a traffic net on 1.7-mc. 'phone. How about it, boys? The Regina gang held first meeting of 1933, 20 present. VE4AT was QSO G6QB.

Traffic: VE4BB 226 AT 161 CM 90 HG 54 EL 26 AZ 22 GI 16 IY-MH-LI 15 AV 10 GO 7 GR 5 KA 4 BF 7 CC-MT-EH-JH 2 KM 1 AU 177 MX 4.

## Wright Memorial Flight

PLANS for the Wright Memorial Flight are now nearing completion. This is a 17,000-mile flight being planned in commemoration of the 30th anniversary of the Wright Brothers' flight in 1903. The plane is being equipped with radio apparatus to operate in the 6150-6675 kc. mobile channel adjacent to the 7-mc. amateur band. The exact frequency and call signal will be announced later via A.R.R.L. OBS. Considerable two-way work with amateurs is planned. The flight will start around the first of May taking the following course: Dayton, Ohio to Washington to New York to Harbor Grace, Newfoundland to Dublin, Ireland to London to Paris to Berlin to Prague, Czechoslovakia to Vienna to Rome to Marseilles, France to Barcelona, Spain to Madrid to Seville to Rabat, Morocco to Freetown, French Guinea, across to Natal, Brazil to Caracas, Venezuela to Havana, Cuba to Miami, Florida, and so back to Dayton. Amateur coöperation has been requested, especially from those amateurs along the route willing to act as "official listening stations." Anyone interested in acting as such should communicate with Mr. R. S. Copp, Stratford at Monument Ave., Dayton, Ohio, who is in charge of radio arrangements. The transmitter to be used during the flight has been on test at W8WI and reports on reception of this station up to the time of "take off" will be appreciated by Mr. Copp.

## Phillips Code Abbreviations

By Ellis Rawnsley\*

THE Phillips Code was worked out by Walter T. Phillips, an old-timer on the then flourishing Morse wires, along in 1879. Phillips' idea, of course, was to permit fast handling of news copy on Morse wires, and it was there that the code found its greatest use. Advent of teletypewriters is gradually forcing it out of existence, though I believe the old code now is in use as the basis of a simple shorthand system. Using code intelligently, Morse operators have been able to make great speeds. I have been told — and have no reason to question the statement — that within recent years it has not been uncommon for speeds up to 60 and 70 words a minute to be made on the Associated Press main traffic artery, New York to Kansas City. A good operator can, and does, average 38 to 40 words a minute over an eight-hour stretch, handling everything from straight news to tabular matter.

This is *real* operating. The fastest operators don't push or rush the boys. The sending is absolutely steady, rhythmic, and even, intelligently coded and intelligently spaced. A joy to hear. Talk about music. There's a thrill to working with really good operators, whether on radio or wire circuits — a thrill that can't be duplicated. Every operator should strive to BE such an operator.

The rules for using code, or straight stuff, apply to any transmissions. (1) Send at an even, moderate speed. (Top speed often defeats its own purpose.) (2) Characters should be well spaced so that the receiving operator doesn't have to puzzle it out in a hurry and lose track of what he is copying. (3) Use code or abbreviations sparingly at the beginning of sentences, never where the code makes good English that would fit (erroneously) into the context. (4) If the receiving

\* Associated Press, Times-Star Building, Cincinnati, Ohio.

operator balks on abbreviation, spell it out, and then repeat the abbreviation and go on.

In noting the different abbreviations used in amateur work, it is apparent that many of the derivations are obtained phonetically, and some are very similar to Phillips Code. Some of the standardized code words make possible additions to the vocabulary of the amateur traffic-moving fraternity, and this thought has led to the presentation of this brief article explaining Phillips Code usages in part. The list of words given herewith is very incomplete, since an attempt has been made to pick only the representative and more useful abbreviations from a radio standpoint, and to avoid abbreviations (such as AR K ICW OW OM SK CQ- and Q-combinations) which have distinct and commonly known and used meanings in radio parlance, and which would only create confusion on amateur channels.

The entire system (Phillips Code) is built around cutting words to their "backbone"—the letters that carry the brunt of the pronunciation. In that respect it is somewhat phonetic. Then, having the root, variations of tense, etc., are indicated merely by addition of a letter or by changing the last letter of the root coded word. So logically is it carried out in most cases that one almost naturally would abbreviate exactly the same way if forced to abbreviate at all, and, once the root is known, the last letters indicate the tense, form, etc., so clearly that there is no difficulty there. Variations from that practice, of course, result from peculiarities of the Morse Code.

To illustrate: "AK" is the code for "acknowledge." Then we have akd, akg, akm—almost without my telling you'll know that those are acknowledged, acknowledging, acknowledgment. "XC" is "excite." Knowing that you'll have no trouble in deciphering xcd, xcg, xcm, and I'll invent one of my own for "ham" use that also is easy: xcn—excitation.

In learning Phillips Code, it's best to start with these:

|              |              |
|--------------|--------------|
| *B—be        | Q—on the     |
| *C—see       | *R—are       |
| D—in this    | *T—the       |
| F—of the     | *U—you       |
| G—from the   | V—of which   |
| H—has        | W—with       |
| J—by which   | X—in which   |
| K—out of the | Y—year       |
| M—more       | Z—from which |
| *N—not       | *4—where     |
| O—of         | 5—that the   |
| P—per        | 7—that is    |

A short alphabetical list, illustrative of the general system, follows:

|                         |                      |
|-------------------------|----------------------|
| ab—about                | agd—agreed           |
| abb—abbreviate          | agup—agreed upon     |
| abbd—abbreviated        | aj—adjust            |
| abbg—abbreviating       | ajd—adjusted         |
| abbn—abbreviation       | ajm—adjustment       |
| abc—absence             | ajs—adjusts          |
| ads—address (adr—radio) | ak—acknowledge (QSL) |
| adsd—addressed          | akd—acknowledged     |
| advc—advance            | akm—acknowledgment   |
| advcd—advanced          | aks—acknowledges     |
| advcg—advancing         | alg—along            |
| ampf—amplify            | laby—laboratory      |

\*Phillips Code abbreviations so indicated are already substantially well known and used by amateurs generally.

EDITOR'S NOTE.—*Re abbreviations:* Perhaps a word to new hams is in order, to explain that abbreviations are fine in their place . . . in ham conversations, in service messages. Thus used they are great time savers. However, it is altogether *improper* to abbreviate words in the *texts* of regular messages. To do so invites errors to creep into messages, and increases the number of garbled messages.

The second "unpardonable sin" of an operator is to make unauthorized changes in the texts of messages passing through his hands. Any questionable text should be made the subject of service messages to the originating and delivering stations. Messages should be relayed and delivered *exactly as received*, with any explanation required for clarity.—F. E. H.

|                         |                    |
|-------------------------|--------------------|
| ampfd—amplified         | laf—laugh          |
| ampfn—amplification     | ltr—letter         |
| ampfr—amplifier         | *luk—look          |
| amt—amount              | *lv—leave          |
| amtd—amounted           | m—more             |
| amtg—amounting          | mab—may be         |
| amts—amounts            | max—maximum        |
| ax—ask                  | mdl—middle         |
| axd—asked               | mdm—medium         |
| axg—asking              | mit—might          |
| any4—anywhere           | mid—midnight       |
| *b—be                   | my—many            |
| bca—became              | mof—matter of fact |
| bcm—become              | mol—more or less   |
| bd—board                | *mtg—meeting       |
| bf—before               | *n—not             |
| bfb—beforehand          | nr—near (number)   |
| bk—break                | nu—new             |
| bld—build               | nx—next            |
| big—building            | o—of               |
| bif—built               | ofr—offer          |
| bn—been (between—radio) | *opr—operator      |
| bng—bring               | p—per              |
| bnh—beneath             | pc—per cent        |
| *c—see                  | pnt—point          |
| ca—came                 | ppn—proposition    |
| cal—calculate           | *r—are             |
| cald—calculated         | rmx—remarks        |
| calg—calculating        | rt—are the         |
| caln—calculation        | rtn—return         |
| cau—cause               | rtd—returned       |
| cfi—confidential        | rtg—returning      |
| cfy—confidentially      | ru—are you         |
| cfy—chiefly             | sdn—sudden         |
| *ckt—circuit            | sm—small           |
| clr—clear               | sn—soon            |
| clrd—cleared            | snd—send           |
| clrg—clearing           | stn—station        |
| dl—deliver              | sty—steady         |
| *dlid—delivered         | sug—suggest        |
| dlg—delivering          | svc—service        |
| *dly—delivery           | svl—several        |
| dt—do not               | sxh—sixth          |
| dx—does                 | t—the              |
| ea—each                 | tcy—technically    |
| efi—efficient           | tel—technical      |
| efy—efficiency          | tkt—ticket         |
| emjy—emergency          | tmt—transmit       |
| engr—engineer           | tmd—transmitted    |
| enprd—engineered        | trng—transmitting  |
| enrg—engineering        | trn—transmission   |
| exp—express             | *tnk—think         |
| ey4—everywhere          | tr—there           |
| *fm—from                | *tt—that           |
| fmd—formed              | tti—that is        |
| gr—ground               | ttt—that the       |
| *gv—give                | *u—you             |
| gvg—giving              | uc—you see         |
| gvn—given               | ukn—unknown        |
| h—has                   | *ur—your           |
| *hr—here                | v—of which         |
| *hrd—heard              | vf—verify          |
| hrg—hearing             | vol—volume         |
| hry—hurry               | *vy—very           |
| *hv—have                | w—with             |
| hvb—have been           | wd—would           |
| hvnb—have not been      | wh—which           |
| hvr—however             | wo—who             |
| hvu—have you            | wr—were            |
| hvy—heavy               | *wrk—work          |
| inc—increase            | wy—why             |
| int—interest            | xc—excite          |
| j—by which              | y—year             |
| kpg—keeping             | z—from which       |

Gedney Rigor, W3QL, SCM Southern New Jersey, has been presented with a Silver Loving Cup by the South Jersey Radio Association in recognition of the high standard of his station and activities. Congrats, QL, OM.

The following contribution by Mr. H. F. Lampe, Jr., W2DQD, wins the C. D. article contest prize for this month. The article by Mr. Trombly wins second honorable mention. Your articles on any phase of amateur communication activity are likewise solicited. See the announcement page 56 March 1933 QST. Send yours today. — F. E. H.

## On Operating Practice

By H. F. Lampe, Jr., W2DQD\*

**I**N commercial radio it is customary to use the system of making a call three times, followed by the letters DE and signing the calling station's letters three times. The A.R.R.L. regulations, in addition, read: "In amateur practice this procedure may be expanded somewhat as may be necessary to establish communication. The call signal of the calling station *must* be inserted at frequent intervals for identification purposes."

It can be seen readily that a station calling CQ is using most of his time signing his letters if the unmodified 3 x 3 call is used. It is no more tiresome to listen to a few more CQ's than to hear a station ramble through his call letters three times straight indefinitely. It would seem to me more sensible for a station to call CQ six times and sign his call twice, this way: CQ CQ CQ CQ CQ DE W2DQD W2DQD AE. A station calling CQ is trying to attract another station. His call should be so made that a little more than half the time should be spent making it understood that he desires contact. After all, in a CQ call, the idea is to attract stations' attention, not to advertise one's call letters.

Any amateur able to obtain his license should be capable of grasping a station's call, after being sent twice, at intervals, at a reasonable rate of speed. The majority of "hams" seem to CQ more than they sign, and it is due to this fact and from personal experience that I believe the system mentioned here is most effective.

If a person goes to the expense of installing apparatus and spending time operating it for communication purposes, he expects to be able to use it for his enjoyment, and because one person may have a bit more to say than another he should not be reprimanded for that. So, while high efficiency in operating is commendable and superfluous transmission should be reduced to the minimum, no station should be condemned for "gabbing" or rag-chewing when in contact with another. Sometimes one may have more to speak of than a mere exchange of reports.

I am in favor of the minimum of power<sup>1</sup> being used in the case of powerful stations, when communicating locally. Upon listening to some of them, one would think there was no one else on the air from the amount of consideration shown at times. One station, using superfluous power, is capable of causing unnecessary local interference to other nearby stations. Undoubtedly, some consideration could be shown to others by those violating this custom of good fellowship.

## Traffic Briefs

From W9BLK-HPU: "I was QSO via telephone with W9ABJ the other day, and he told me that a ham in Tennessee gave him a report on his signals of '500 cycle p.d.c.' Quite a report!"

\* Box 85, Quaker St., Chappaqua, N. Y.

<sup>1</sup> This suggestion regarding the use of "minimum power" for local communication is most constructive. Why pay a big electric light bill, and raise a lot of local QRM at the same time? It's all so unnecessary. A simple provision for (1) changing taps on h. v. power supplies, or (2) inserting a suitable resistor in the plate circuit of the "big" tubes (which can be cut in just by opening a switch), or (3) switching the radiating system to a low power amplifier stage (also keyed) instead of using the big "final" amplifier, will accomplish the desired result.

It's just good common sense, and a lot of fun too, to cut down to five or ten percent of your maximum plate input, and tell your neighboring operator "how you do it," when working local. Low power DX records are sometimes made that way, too! — F. E. H.

## Reducing QRM

By Lawrence Trombly\*

**S**OMEbody suggested that we make two-minute calls when calling stations. Supposing we call this the maximum amount of time for a call. It is not always necessary to call this long. For instance, we hear a station calling CQ on 7025 kc. and we know our own frequency (every amateur should know his approximate frequency) to be 7035 kc. When calling this amateur we need give him only a short call. He knows his frequency to be 7025 kc. and he invariably begins listening for answers to his CQ at the 7000-ke. end of the band. If he can hear us, he will hear us right away; while if we called for a longer time, he might become disgusted and tune off our frequency.

Most of us start listening at the end of the band which our own frequency is nearest.

Theoretically half of the stations we call would be in the same half of the band as ourselves. We would use the two-minute call when the station being called was at the opposite end of the band from ourselves. Using this plan we can save power and avoid useless QRM on half our calls. I have used it on the three most popular bands, making calls of as little as half a minute's duration with good success.

\* 116 Westwood Ave., Columbia, Mo.

## O. B. S.

The following is a supplement to the list of A.R.R.L. Official Broadcasting Stations in November QST\* (page 51): WIADF, W2FF, W3AQL, W4BSJ, W5CWM, W6DYQ, W6HHM, W9DXV.

W8FFK, Cleveland Heights, Ohio, is sending code practice on 1961 kc. every Tuesday and Thursday, 8:00-8:30 p.m. E.S.T.

## ELECTION RESULTS

Valid petitions nominating a single candidate as Section Manager were filed in a number of Sections on or before the closing dates that had been announced for receipt of such petitions. As provided by our Constitution and By-Laws, when but one candidate is named in one or more valid nominating petitions this candidate shall be declared elected. Accordingly election certificates have been mailed to the following officials, the term of office starting on the date given.

|              |                             |               |
|--------------|-----------------------------|---------------|
| Utah-Wyoming | Cutler R. Miller, W6DPJ     | Jan. 15, 1933 |
| Sacramento   | George L. Woodington, W6DVE | Feb. 15, 1933 |
| Valley       |                             |               |
| Manitoba     | Reg. Strong, VE4GC          | Feb. 15, 1933 |
| Los Angeles  | Francis C. Martin, W6AAN    | Feb. 24, 1933 |

In the Maritime Section of the Maritime Division, Mr. A. M. Crowell, VE1DQ and Mr. George E. Panter, VE1BL were nominated. Mr. Crowell received 18 votes and Mr. Panter received 9 votes. Mr. Crowell's term of office began January 18, 1933.

In the San Francisco Section of the Pacific Division, Mr. Byron Goodman, W6CAL and Mr. R. G. Martin, W6ZF were nominated. Mr. Goodman received 47 votes and Mr. Martin received 39 votes. Mr. Goodman's term of office began January 18, 1933.

In the Michigan Section of the Central Division, Mr. Kenneth F. Conroy, W8DYH and Mr. Harold E. Falk, W8PP-W8UU were nominated. Mr. Conroy received 190 votes and Mr. Falk received 110 votes. Mr. Conroy's term of office began February 9, 1933.

## Getting Your QSLs?

QSL cards are pouring into HQs by the hundreds as a result of the DX Contest. There may be some for you! Send a stamped envelope to the QSL Manager for your district (see page 29, March QST, and page 34, April QST for address) so that you won't miss any.

## BRASS POUNDERS' LEAGUE

(FEBRUARY 16TH-MARCH 15TH)

| Call      | Orig. | Del. | Rel. | Total |
|-----------|-------|------|------|-------|
| W6BYE     | 2436  | 150  | 44   | 2630  |
| W6GJD     | 1501  | 499  | —    | 2000  |
| W9VS      | 27    | 390  | 1408 | 1825  |
| W6BRV     | 9     | 9    | 1804 | 1822  |
| W2DIJ     | 314   | 207  | 1138 | 1659  |
| W6FG      | 392   | 195  | 537  | 1424  |
| W3BKQ     | 122   | 1208 | 77   | 1407  |
| W6GSR     | 500   | 500  | 400  | 1400  |
| W5OW      | 185   | 139  | 1069 | 1393  |
| W9AUX     | 151   | 85   | 1156 | 1392  |
| W3CXL     | 215   | 233  | 848  | 1296  |
| W6HAQ     | 1280  | —    | —    | 1280  |
| W6ETM-CQM | 10    | 19   | 1234 | 1263  |
| W9ESA     | 20    | 70   | 1136 | 1226  |
| W6GOY     | 138   | —    | 1000 | 1138  |
| W9JTD     | 102   | 64   | 956  | 1122  |
| W9BN      | 50    | 59   | 1008 | 1117  |
| W9HGG     | 220   | 194  | 688  | 1104  |
| W1ASF     | 77    | 629  | 367  | 1073  |
| W6EK      | 12    | 8    | 1042 | 1062  |
| W6EDW     | 200   | 205  | 641  | 1046  |
| KA1HR     | 200   | 205  | 590  | 995   |
| W6FEX     | 150   | 750  | 92   | 992   |
| W6EPC     | 794   | 106  | 38   | 928   |
| W3SN      | 222   | 74   | 618  | 914   |
| W1UN      | 270   | 134  | 474  | 878   |
| W6DKM     | 160   | 207  | 474  | 841   |
| W6BMC     | 10    | 36   | 791  | 837   |
| W6UO      | 17    | 14   | 804  | 835   |
| W6CDU     | 109   | 234  | 474  | 817   |
| W9BNT     | 81    | 317  | 417  | 815   |
| W6GWX     | 150   | 150  | 500  | 800   |
| W6FGT     | 21    | 53   | 724  | 798   |
| W6HHM     | 14    | 30   | 752  | 796   |
| W8FP      | 16    | 39   | 715  | 790   |
| W6ANN     | 631   | 34   | 104  | 769   |
| VE3AD     | 45    | 50   | 671  | 766   |
| W6EBK     | 98    | 94   | 568  | 760   |
| W6BTZ     | 24    | 44   | 674  | 742   |
| W9HGG     | 59    | 632  | 638  | 739   |
| W6BSV     | 40    | 121  | 562  | 723   |
| W6ETJ     | 605   | 11   | 100  | 716   |
| W9CSY     | 84    | 83   | 536  | 703   |
| W9KG      | 3     | 32   | 676  | 701   |
| W6AM      | 42    | 115  | 703  | 700   |
| W6DBC     | 12    | 141  | 542  | 695   |
| W9CVE     | 2     | 20   | 664  | 686   |
| W8DZ      | 47    | 30   | 603  | 680   |
| W6RPU     | 73    | 153  | 452  | 678   |
| W6BT      | 312   | 196  | 152  | 660   |
| W9DGS     | 32    | 35   | 592  | 659   |
| W5AUW     | 205   | 50   | 402  | 657   |
| W3BWT     | 106   | 148  | 402  | 656   |
| W8BAH     | 228   | 165  | 260  | 653   |
| W6DQN     | 30    | 44   | 670  | 644   |
| W6FVY     | 143   | 120  | 368  | 631   |
| W9JNV     | 81    | 26   | 524  | 631   |
| W7AAT-COX | 11    | 12   | 607  | 630   |
| W9AMB     | 230   | 111  | 230  | 621   |
| W9FUT     | 30    | 61   | 515  | 606   |
| W6RO      | 493   | 158  | 154  | 605   |
| W3NE      | 145   | 175  | 304  | 604   |
| W1CJD     | 9     | 43   | 552  | 604   |
| W6ETL     | 71    | 106  | 426  | 603   |
| W5BMI     | 23    | 38   | 540  | 601   |
| W9BNH     | 21    | 30   | 550  | 601   |
| W3CL      | 84    | 182  | 331  | 597   |
| W9LN      | 10    | 9    | 552  | 571   |
| W6GXW     | 70    | 100  | 400  | 570   |
| W8DVL     | 27    | 56   | 486  | 569   |
| W3AQN     | 336   | 114  | 117  | 567   |
| W9FSS     | 258   | 196  | 100  | 554   |
| W4WZ      | 3     | 9    | 542  | 554   |
| W6AFO     | —     | 150  | 400  | 550   |
| W9DHA     | —     | 13   | 490  | 541   |
| W2BZZ     | 28    | 33   | 476  | 537   |
| W8PO      | 63    | 66   | 400  | 529   |
| OM1TB     | 218   | 70   | 242  | 525   |
| W8YA      | 39    | 76   | 356  | 521   |
| W9FLG     | 36    | 34   | 450  | 520   |
| W5BKE     | 44    | 15   | 460  | 519   |
| W8CPE     | 170   | 160  | 188  | 518   |
| W3C3S     | 55    | 155  | 306  | 514   |
| W8EJ      | 19    | 46   | 448  | 513   |
| W8AEQ     | 50    | 12   | 450  | 512   |
| W5BED*    | —     | —    | —    | 507   |
| W6EII     | 74    | 297  | 132  | 503   |
| W9HJC     | 13    | 21   | 469  | 503   |
| W1BFE     | 17    | 28   | 456  | 501   |

\*These stations "make" the BPL with totals of 500 or over. Many "make" extra credit for one hundred or more deliveries. The following make the BPL for delivering 100 or more messages; the number of deliveries are as follows: Deliveries count!

|            |            |            |
|------------|------------|------------|
| VE3WX, 246 | W8DDS, 129 | W8EIS, 111 |
| W6GVU, 220 | W1FEX, 123 | W6NF, 110  |
| W9NP, 212  | W6EKZ, 123 | W6DYV, 110 |
| VE3CT, 204 | W7EB, 115  | W6DEB, 109 |
| W6HM, 196  | W6YG, 113  | W8EEQ, 104 |

\*Listing for this station for Dec.-Jan.

## The Hammond Memorial Bug

A few years ago the East Bay Section, A.R.R.L., presented the late W. A. Hammond, W6ALX, with an Electro Bug in appreciation of all he had done for the Section. In 1931, Mr. Hammond passed away and his widow returned the bug to the Section. It was decided to put it up as a Traffic Trophy to be known as the "Hammond Memorial Bug," to be awarded to the East Bay Section amateur having the highest traffic total for the period April 15-October 15, 1932, and for each six months period after October 15, 1932. No amateur is to receive the award two consecutive periods. The Bug is enclosed in a case and the calls of the various winners will be engraved on a plate attached to the case. W6CDA is the first call to be engraved, the operator of that station having received the first award. FB, OM.

## About Harmonics

"I hear hams regularly halfway between the 3.5 and 1.75 mc. bands, also between 7 and 3.5 mc., and most of them are tuned up there. The fault is not in the hams' intentions. I called several of them when they CQ'd and found they were using harmonic monitors. That part is OK, but they were listening to the wrong harmonic! A plain old-fashioned 'wave meter' or absorption-type frequency meter such as used in days gone by will stop this. Most anyone can rig up a condenser, coil and flashlight bulb, and find the band with it. Then the harmonic monitor will do the rest."

— R. E. Craig, W9DLX-KVS

## Amateur Radio Again!

Red Lake, Ontario, has no wire telegraph outlet; the Canadian Forestry Department operates radio stations at Red Lake and Sioux Lookout, but no operator is on duty at Sioux Lookout after 5:00 p.m. An epidemic of "fu" broke out at Howey Gold Mines (at Red Lake) and their supply of lemons ran out. The only means of transportation to Red Lake other than dog team during the winter period, is the "one-plane-a-week," which left Sioux Lookout the following morning at 8:40 a.m. And those lemons were needed immediately. That was the problem. What to do? The radio operator at Red Lake (call unknown) tried ham radio. At about midnight he hooked W9FSEK, Escanaba, Mich., who took the traffic (destined for Sioux Lookout requesting that a case of lemons be shipped via plane the next morning). Since his local telegraph office was closed he tried to raise Chicago, Minneapolis or Milwaukee so that the traffic could be rushed by wire from one of those points. Noting that W9FSK was having difficulty in raising anyone, W2AFV came to the rescue and had W9FSK QRX while he called "QST Urgent Chicago." W9GVX/MW (Chicago) guarded W2AFV's frequency and after trying for three quarters of an hour raised him. W2AFV then took the traffic from W9FSK, and relayed it along to W9GVX/MW, who sent it via W.U. to Sioux Lookout. The case of lemons went via plane the following day and reached Howey Mines in time to aid the "fu" victims. FB, W9FSK, W2AFV, W9GVX/MW and radio operator at Red Lake! You have "chalked up another" for amateur radio!!

## Chess by Radio

A new and novel experiment to Missouri Amateurs was begun on Sunday, March 5th, and completed with a high degree of satisfaction just one week later. We refer to "Chess

|            |            |            |
|------------|------------|------------|
| W8AWX, 190 | W8ANV, 117 | W9FJV, 103 |
| W8FX, 142  | W8ZZC, 116 | W9BMA, 102 |
| W6EQM, 140 | W6AF, 116  | W6MV, 102  |
| W9BGW, 138 | W8EDG, 115 | W6GX, 101  |
| W3CXM, 131 | W6FUF, 113 |            |

A total of 500 or more, or just 100 or more deliveries will put you in line for a place in the B.P.L. Make more schedules with reliable stations. Take steps to handle the traffic that will qualify you for B.P.L. membership also.

by Radio" conducted by two member stations of The South Missouri Association of Radio Amateurs, W9CJR, Mount Vernon, and W9HUI, Springfield, W9HUI, W9GMI and W9FUM operators. W. W. Livingston of Mt. Vernon played and defeated six opponents from Springfield. During the progress of the six games, which were carried on simultaneously, there were 442 moves transmitted, with some 30 explanatory messages. A combination of both 'phone and c.w. was used at W9HUI while W9CJR used c.w. exclusively, 3.5 mc. band at both stations. Should anyone care to try a similar game, W9CJR and Mr. Livingston will be glad to work with you.

— C. R. Cannady, W9EYQ

The Coshocton Radio Traffic Association, one of Ohio's most active A.R.R.L. affiliated clubs, was founded back in 1925. Reorganization in 1928 placed it on a solid basis under which it has been operating now for about five years. Among the active members are W8CSP, CBC, HDD, FXL, CKX, CCA, EML, GXX, HRU:

### Low Power Records

W2BJZ suggests that it would be a very good idea to compare the records of all hams using below 200 volts for plate supply, to see just what "flea power" can do in each of our different bands.

Who has the miles-per-watt record for DX (two-way QSOs) on 1715 kc? 3500 kc? 7000 and 14,000 kc? Send us your DX-record, if you have operated a set which can be classified as "low power." Give us the data on plate current, plate voltage, and enclose the QSL you received confirming the work.

Try your hand at low-power work this fall, if you have never tried it before — and let's hear your results.

Here are some items of interest regarding "low power communication": W1EZ, Pownal, Vt., in contact on 3.5 mc. at 2:10 p.m. with W1APQ, Hampstead, N. H., cut power to 15 volts at 2 mills was QSA4 R3 at W1APQ. . . . G5UM was in communication with G2ZN, about six miles away on the 1.75-mc. band. G2ZN reduced power, and when using 10 volts at .5 MA was QSA8 R2 at G5UM. This is about 1200 miles per watt! G2ZN was also heard R3 by G5RS when using .35 watt, about 1000 m.p.w. . . . One evening at 8 p.m. W3CMQ contacted VE3JS on the 3.5-mc. band. W3CMQ was using an '01A with 180 volts; VE3JS was using a 199 with 150 volts! . . . During the 1932 DX tests W2DEE was heard in Germany on the 3.5-mc. band. Looking back in his log he finds that at

the time he was heard he was using a '26 with 450 volts on the plate, 50 mills current, 2½ volts on filament. A 7-mc. antenna was used at the time with 15-foot zepp feeders. Who said it didn't pay to keep a log?

### Phone Relaying

A group of third district 1.7-mc. 'phones recently did a good piece of relaying. W3AYH received a message for Camden, N. J. He relayed to W3BYJ, who called "CQ Camden." W3CPA and W3CMR, who were QSO, came back. W3CPA was unable to receive W3BYJ 100% so W3CMR took the message and relayed it to W3CPA, who gave the OK to W3BYJ, the latter being unable to receive W3CMR 100%. W3CPA then relayed to W3CUX, who delivered, received an answer and relayed it to W3BYJ. W3BYJ relayed to W3BCR. W3BCR delivered the return message and gave the other stations an OK. This bit of work took but 2 hours and 10 minutes. FB.

Down in North Carolina there is a ham who claims to be "The World's Youngest Wireless Operator" — Charles Beard, W4ZM-IJ, 164 Bartlett Street, Asheville, N. C., 10 years old. And out in Kenmore, N. Y., there is a young lady, who can possibly claim the title of "Youngest YL Wireless Operator" — Miss Josephine Rohas, W8EKM, age 13. Any other bidders for these titles?

W9BWJ, Paintsville, Ky., has been heard twice on the 3500-kc. band by ZL2CZ.

Ham doings at Rensselaer Polytechnic Institute (by W2WP): W2AGO/BOB was in algebra class; he and other chaps were putting problems and theorems on the board. The fellow next to him was working on something difficult and while standing there trying to figure it out he sent . . . in a low whistle under his breath. W2AGO, when he recovered from the shock, sent . . . and it turned out that the other chap was W8AGA. A new way to meet a fellow ham! . . . The first night at the school W2DES opened his window and called CQ on a trumpet; all the homesick hams within "earshot" made speedy tracks for his house. Hi. . . It's reported that one ham has a trailer which he attaches to his car, and when night falls he goes through the streets dispensing hot dogs, calling "QST" on his horn. Business should be good!

### Relative Standings of the Ten Highest Sections—Feb.—Mar.

| Messages Per Station (25%) | Stations Reporting Traffic (25%) | Gain or Loss (Traffic Reports) (25%) | Traffic Total (25%) | Standing Based on Average of All Four Ratings % | Section Communications Manager |
|----------------------------|----------------------------------|--------------------------------------|---------------------|---|--------------------------------|
| M.-D.-D.C. 289.6           | Los Ang. (680)* 196              | Okla. +14                            | Los Ang. 36881      | Los Angeles 67.5                                | Martin, W6AAN                  |
| S. Tex. 330                | Mich. (624)* 131                 | S. C. V. +11                         | Mich. 7194          | Michigan 45.                                    | Conroy, W8DYH                  |
| P. I. 214.2                | Ill. (890)* 80                   | Va. +10                              | Wis. 6267           | Illinois 42.5                                   | Hinds, W9APY-WR                |
| Low Ang. 188.1             | Va. (158)* 74                    | Mont. +8                             | Ill. 6022           | Virginia 37.5                                   | Eubank, W6AAJ                  |
| W. Pa. 183.8               | Wash. (374)* 73                  | Ariz. +8                             | Es. Pa. 5808        | M.-D.-D.C. 32.5                                 | Ginsberg, W3NY                 |
| E. Pa. 170.8               | Ohio (868)* 67                   | B. C. +6                             | S. Minn. 5699       | E. Pennsylvania 27.5                            | Wagenseller, W3GS-BF           |
| E. Bay 165.2               | Mo. (324)* 57                    | Idaho +6                             | Ohio 5251           | Wisconsin 27.5                                  | Kurth, W9FSS                   |
| S. Ninn. 149.9             | Wis. (353)* 45                   | San Die. +5                          | M.-D.-D.C. 5214     | Oklahoma 25.                                    | Gisel, W5VQ                    |
| Colo. 145.7                | Ore. (260)* 45                   | Ill. +4                              | W. Pa. 5149         | Ohio 22.5                                       | Tummonds, W8BAH                |
| Neb. 143.4                 | Kans. (244)* 43                  | Ont. +4                              | Kans. 4138          | Santa Cl. V. 22.5                               | Stone, W6AMM                   |



LOS ANGELES sweeps into first place on the tide of Earthquake traffic activity, leading all other Sections with the highest total ever claimed by any one Section, 38,881! The National total of 189,874 is also a "record breaker." The following Sections lead all other Sections in their Divisions, order of listing showing relative standing of their different Divisions: Los Angeles, Eastern Pennsylvania, Southern Texas, Michigan, Eastern Massachusetts, Kansas, Southern Minnesota, Colorado, Montana, Ontario, Northern New Jersey, Virginia, Tennessee, Alabama. During the February 16th-March 15th month, 2030 stations originated 39,548; delivered 30,136; relayed 120,190; total 189,874. (76.4% del.) (93.4 m.p.s.)

\* Section A.R.R.L. membership shown by ( ) % reporting traffic: Va. 46.7%, Los Ang. 28.8%, Mich. 21%, Wash. 19.5%, Mo. 17.6%, Kans. 17.6%, Ore. 17.3%, Wis. 12.7%, Ill. 9%, Ohio 7.7%.

## DIVISIONAL REPORTS

### ATLANTIC DIVISION

**WESTERN NEW YORK** — SCM, Don Farrell, W8DSP — W8CRF says Gloversville has gone 56-mc. crazy. W8GWZ is returning from Florida. W8AFM is building secondary frequency standard. W8BGN is QRL WHAM. W8QB is on 14 mc. W8AKX worked LA1G. W8IEM and W8BMN did some nice emergency work during sleet storm. W8AJJ hopes to win ORS. It is with sincere regret that I report the death of Ralph Rienen, W8CHG. The new Geneva Club meets every Monday at 7:30 p.m. at Y.M.C.A. W8CUY has a QSO party every Sunday morning. W8IGR is new ham. W8CGU moved to Oneida. W8GAR, EXT, PSG and HZA built a.c. receivers. The Adirondack Amateur Radio Club will hold a big hamfest on May 30th at Hotel Flanagan in Malone. W8DT sold his '04A. W8AIK visited W8DT. W8DSP is c.c. on 3826 kc.

Traffic: W8AWX 478 BDK 410 DSS 309 FDY 287 AOW 259 BJO 288 DJI 236 DBX 194 BFF 158 BR 58 CPC 61 CJJ-BHK-DHU 40 HKF 36 DMJ 35 QL 23 EUY 20 GWS 17 DME 12 FMX-DHQ 10 FTB 8 AYU 7 BFG-AGS 4 GWT 2. JE 402 CBK 69N 6PN 27 IY-CQW 24 GPT 18 TZ 12 JV 8 ERU-GWY 6 GEH 2 FYF 4 FFU 3 ABM 9 BWY 91.

**EASTERN PENNSYLVANIA** — SCM, Jack Wagen-seller, W3GS-BF — W3AQI has been appointed OBS. W3BBV is doing nice OQ work. W8EU is having hard time finding room for 3.5-mc. Zepp. W3BIS, Beckley College, is on regularly. W3CUI, Lehigh Valley Radio Club, wants schedules all directions. W3AZT is working many sixes on 1.7-mc. low power 'phone. A new club has been formed in Royersford. W3AQN, BKQ and CL make the BPL.

Traffic: W3CHU 29 AZT 55 ABT 127 CIA 10 MC 359 YC 326 CY 7 ALX 294 CUI 50 ABZ 44 BIS 116 BNK 10 AGK 25 CWO 44 AQN 567 CEM 4 TX 58 CL 597 AAV 37 APX 2 NF 45 AKB 169 BEY 424 ADE 9 BKQ 1407 NU 263 BRH 329 BF 45. W8CVS 179 FLA 40 CFI 78. CFF 105. W8EOH 60, W3BLS 17, W3BPX 12.

Omitted April QST (Jan.-Feb. traffic) W3ABZ 51, AZF 2, BHD 22, CLG 2, BUK 2, ATR 8, AHD 316, AQN 379, W8CVS 433, CFI 106.

**WESTERN PENNSYLVANIA** — SCM, C. H. Gros-sarth, W8CUG — W8HGG makes the BPL!! W8YA is trying to get to 14 mc. W8EDG wants to schedule Pitts-burgh for World's Fair traffic. W8EIS was in a QRR route to west coast night of recent quake. W8BWL says U.S.N.R. unit being formed in Altoona. W8CCD wants a schedule with Los Angeles. W8AJE, CPE, FRA, DYV and AAQ report by radio. W8GBC has portable W8INC. W8WQ sends first report. W8FFD reports on Sylvania Transmitting Amateurs Association. W8AVY is working sixes. W8BSO is moving to the top of nice high hill in preparation for 56-mc. monkeying! W8CUG has been busy with PSP contest. W8DKL just gets his report under the wire.

Traffic: W8HGG 1104 YA 521 EDG 421 CPE 518 CUG 365 EIS 357 BWL 285 CCD 252 AJE 202 DYV 199 AAQ 155 GBC 140 FRA 123 WQ 105 DYL 95 DLG 57 AEG 43 FKU 42 GUB-ELZ 32 CMP 25 FFD 20 CFR-FVN 16 CTG 12 DXI-CRZ 5 DZQ 2.

**SOUTHERN NEW JERSEY** — SCM, G. M. Rigor, W3QL — W3APN handled message after message on the quake. The largest turnout ever staged in So. Jersey was held at the S.J.R.A. when the satellites of radiodom were there; such as Herndon, Sterling, Kearney, Davis, Leach. Over 225 prominent hams were present. W3ZI is new RM in Trenton; he did fine work on GPR. W3ATJ heard all continents on 14 mc. W3APN worked 'em all. W3QL has gone to 14 mc. W3BDO handled quake traffic. W3CRC had a tank coil that vibrates at voice frequencies. W3APV stood by for quake traffic. W3CNR worked EAR96 on 7 mc. Reports received and appreciated from: W3CLW-ARP-ARI-UT-ARW-LT-BVE-BIU-BWW-CBR-PC-BUF-BIN-CRC-CRK-ATL-BTS-BTW-AGJ-ACX-PCX-BFT-BGT-TH-ATJ-ZI.

Traffic: W3APN 449 AEJ 40 AOV 38 BDO 5 BUU 1 AZZ 6 BLV 1 QL 14 CWL 16 APV 1 AYA 2 BYR 14 CLQ 9 IS 3 ZX 6 BAA 2 ASG 3 ZI 7 ARV 8 AXU 3 BYM 44 BEI 13.

MARYLAND-DELAWARE-DISTRICT OF COLUM-

BIA — SCM, Harry Ginsberg, W3NY — W3BAK, SN, BWT; RMs. W3CXL, BWT, SN and CJS make BPL. Send those stamped self-addressed envelopes to W3CQS, our QSL Manager. F. C. McMullen delivered a lecture on "Aircraft Radios" March 17th, at the monthly meeting of the Institute of Radio Conferes held at J.H.U. The Baltimore Amateur Radio Association has been formed with 15 charter members. Meetings are held every other Friday at W3ADB's shack. W3CQS, VJ, ADP, BAK, BCS, and BYH of the Delmarva Amateur Radio Club visited the Chester Radio Club Feb. 19th. The Frederick Amateur Radio Assn., W3CMG, is on the air at new QRA. W3CAC is back with the Westminster Amateur Radio Assn. District of Columbia: W3BWT handled earthquake traffic directly with stricken area. W3ASO used a Comet Pro for GPR. W3NR snagged first GPR message. W3CDQ found GPR lots of fun. W3AJJ's a.c. rig FB. Maryland: W3CDG says traffic getting heavier. W3BXX handled 8 earthquake messages with W6AM. W3ADO has 100 W.c.c. outfit. W3LA says W3AAD and W9BNF "did their stuff" during GPR. W3BHE reports exciting doings night of the earthquake. W3WN reports AKX on with 1934 'phone. W3DG has a new ham to his credit. W3NY is working on receivers. Delaware: W3BAK says his little girl was QSO W3DF, who used 'phone.

Traffic: W3CXL 1296 SN 914 BWT 656 CJS 514 CDG 412 CQS 311 BAK 282 BXX 223 ADO 187 LA 99 CMS 80 BGI 28 NR 22 BHE 19 CIZ 13 AVD 10 ZD 3 ASO 145.

### CENTRAL DIVISION

**KENTUCKY** — SCM, Carl J. Plumm, W9OX — W9BJA leads state. W9KKK handled flock of quake traffic. Is W9JYO stringing the boys? W9OX's pretty mast broke in high wind. W9AUH is lined up for W9USA traffic. W9FQQ is moving to Washington, D. C. W9BAN's traffic increases after joining A.A.R.S. W9DLU is c.c. on 7 mc. W9DQC reaches west coast on 3.9-mc. 'phone. W9ERH is ORS. W9CIM maintains nice list of schedules. W9HCO, HCD and EYW are connecting links between CW and 'phone stations in state net-work. W9BWJ raised a 73-foot mast.

Traffic: W9BJA 367 KKG 278 JYO 240 OX 181 AUH 130 CIM 127 FQQ 126 BAN 108 HAX 83 CNE 61 EQO 49 ERH 45 ARU 39 BAZ-IFM 24 JDR 16 CDA 14 ELL 12 JL 10 LXN 8 ALD 5 FBJ-EYW 2 BWJ 149.

**ILLINOIS** — SCM, F. J. Hinds, W9APY-W9WR — RMs, W9DDE, W9ERU and W9CRT. On 3.5 mc. at W9HWY. W9FGN is building transmitter rack. W9EDW works West Coast on 1.7-mc. 'phone. C.C. at W9ALE and W9HKC. 100-watt MOPA at W9JH. W9FKO secured Illinois GPR message. Zepp at W9BSR. W9HPK is on 1.7-mc. 'phone. New receiver at W9JZP. W9IYA is Alt. NCS in A.A.R.S. W9IYP works Spain. W9KA added seven new countries. W9KOR has c.c. going fine. W9KRI is op at "KYW". W9JZY is doing fine state net traffic with RM W9CRT. W9PKR got R-7 from FM8IH. W9SG worked EAR185 five days. W9HUX is working DX. W9HMB is joining A.A.R.S. Making new transmitter at W9FGV. W9FGD has 1.7-mc. outfit for A.A.R.S. W9EMN is installing new antenna. W9DZG is moving to 1.7 mc. W9KQI is building autodyne receiver. W9DOU is experimenting. W9CNO scheduled W9UZ at W4BRO. W9BUC is back after long rest. W9BRX did well in DX tests. W9AVB is on 1.7 mc. E.C. frequency meter at W9AYO. W9DCI blew rectobulbs. Antenna down in ice storm at W9AFN. DX fine at W9LW. Those deserving special mention in California earthquake traffic handling are W9PCW, FO, PFX, FXE, IUF, KEH, LNV and WR.

Traffic: W9VS 1825 ENH 601 BTT 257 DOU 241 JZY 224 CRT 232 USA 198 IYA 190 IVF 188 CGV 187 NN 144 PCW 110 DBO 102 IEP 93 KEH 82 EDW 78 FKO 73 FO 72 HQQ 67 HQH 66 HKC 65 CNO 64 ILY 58 GSD 56 AFN 49 DSS 41 ILH 41 ALE 36 ACE-CZL-FGV 32 AD-APY 26 DNA 25 PK 24 ICN 23 LW 19 ILG-FXE 18 HUU 17 HMB 16 EMN-IZP 15 FGD 16 JO 14 FGN 13 JUC 12 FDQ-KRL-WR 11 FWD 10 DZG-PTX-HUX-KOQ-SG 9 AVB-AYO-DGK 8 DZU-KA 7 HPK-JIH-IUF 6 GJJ-GZW 5 GIZ-IYP 4 GDI 3 BSR-JLK-KIM-KOR 2 IBA 8 LNI-LNV 2 BRX-BUK-DCI-JFX 1.



OHIO—SCM, Harry A. Tummonds, W8BAH—W8DDS, Chief RM Ohio. Following Ohio stations handled California quake traffic: W8FGV, BMK, WE, HEY, FH. District No. 5 RM W8FGV: W8BSR, DVE, FSK report. W8HWW thinks 7 mc. FB. W8FDV is rebuilding. W8BKR reports by radio. District No. 4 RM W8EEQ, W8FO leads his district. New reporter, W8IJE. BPL for W8EEQ. Doing better at W8AFU. District No. 8 RM W8CGS: HELP W8CGS boost this district! W8BRQ reports. District No. 7 RM W8VP: W8VP spoke at hamfest in Zanesville. New club has been organized: Southern Ohio Radio Assn. W8EQB schedules EAR-225. District No. 3 RM W8APC, W8APC is moving to Holland, Ohio. W8GOD is on the job. W8DIH reports Norwalk Amateur Radio Society will hold low-power contest. Maumee Valley Radio Assn. activity reported by W8EVS. New officers: Pres., W8EELZ; vice-pres., W8GJS; sec'y., W8ARF; treas., W8ESN; sgt. at arms, W8FVB. District No. 6 RM W8BBB: Moving station to club shack, reports W2ZZGA. W8ENH was heard in Netherlands. Schedules at W8BBH: W1MK, 8PP, 30K, 9FUT, 8CGS. W8GZ says, "A.A.R.S." District No. 2 RM W8BKM: A real traffic man is W8EEZ. W8BKM has e.c. frequency meter. Naval Reserve schedules at W8EJ. District No. 1 RM W8DVL: Following stations report: W8HRL, ZZAQ, GMQ, FOO, FGC, FGP, ICN, GME. W8DGQ schedules W8DIH. W8GVL is A.A.R.S. W8BAH sets the pace for the Section. W8RN delivered message advising of serious accident. W8DVL leads this district. W8DDS schedules W9USA. W8FFK will conduct code lessons on 1.7 mc. in April and May. W8FF has been sick. W8GQU says 100 watts input. W8FSE worked EAR185 in DX contest. W8FEW says W6FFW handled important death message from EFW. W8EBY worked EAR185 at W8FJE in DX contest. W8DTP has a few schedules. W8DVI is 100% c.w. W8AUM reports activity of Lorain County Mike and Key Club. W8CJI is on 14-mc. 'phone. W8GPN uses remote control. W8GUS is QRL school.

Traffic: W8BAH 653 DVL 569 PO 529 DDS 475 EEQ 406 BBH 391 RN 361 FGV 230 BKR 175 BKM 158 EEZ 104 FHE 97 GZ 86 WE 82 EQB 65 HEY 84 DIH 52 VP 51 HWV 49 ARU 44 FDV 42 CGS 41 EBY 40 FF 30 GQU 28 DTF 26 EJ-GVL-FFK 19 ENH 18 BMK-GOD 16 ARW 15 DTW-CNM-DPR 14 BAC-ALQ 12 HTL-HBI 10 FRV 13 GSO-ACZ 9 DAT-ELC-GLI 8 DKG-HFZ-BYD 7 GDC-HPW 5 AND-IEJ-GDX-EFW-AUN-UX-ZZB 4 GES 6 CKX-CEJ-AGL 2 CXF-CMY-ANZ-DVI 1. W2ZZGA 65.

WISCONSIN—SCM, Harold H. Kurth, W9FSS—RMs: District 1, W9GVL; District 2, W9AVG; District 3, W9AUX; District 4, W9AZN. School of Engineering has new transmitter; W9BWC is chief opr. there. W9IH worked 18 countries. W9RH worked 14 in DX contest. W9LRB blew power pack. W9GEN worked four "G"s. W9DCE is getting married. W9JBI tries for DX. W9HQC is building. W9EYX moved. W9CZX is working for Postal. W9LJJ lives on river. The Milwaukee Radio Amateurs Club is planning a QSO stag party on May 13th. A new radio club is known as the Rock River Radio Club. It meets first Friday each month at Davies Hall, Watertown, Wisc. W9FTH is on 7 mc. W9FXH's transmitter works with crystal out. W9KTK is going in for DX. W9GEX uses pair of '52s. W9JVD has trouble with a.c. receiver. W9HTN is dry land fishing. W9BJF is star brass-pounder of code class. W9BQM likes 14 and 7 mc. The Fond du Lac Radio Club is sponsoring monthly traffic contest. The Four Lakes Radio Club awarded W9EEQ the cup for traffic. W9BKR turns poet. W9CJU gave a talk at F.L.R.A.C. W9A5M is on 3.5 mc. W9HBH worked Portugal on 14-mc. 'phone. W9LWX says his OW claims he is "nertz." W9LEC is new station with old opr. W9AUX made new high top for Wisc. W9HGG, FSS, and AMB made BPL. W9FSS publishes traffic and news bulletin each month. W9DCT and GYQ are c.c. 56-mc. enthusiasts: W9ESF, LZJ, LAD. QRL U.S.N.R.: W9AFZ, AKT.

Traffic: W9AUX 1392 HGG 739 AMB 621 FSS 554 HSK 344 JDP 323 HMS 272 DRO 214 DXV 146 JCH 144 IYL 119 JCW 117 GFC 96 GQW-AON 84 HNX 82 EYW 83 ERC 77 FAA 65 IHG 55 GWK 52 HYZ 50 ERS 49 GPQ 47 KJR-GVL 46 ZY 34 ESZ 31 HRM 29 KXA 27 GIL 21 DGW 19 EEQ 17 VD 15 KBT 14 DJA 12 DNU-KLF 10

DLQ 4 HKL 3 KLL-KQL 2 AVG 55 GSL 6 AVG 55. MICHIGAN—SCM, Kenneth F. Conroy, W8DYH—See DARA TFC BULLETIN for complete dope on every reporting station. FB on quake and flood work, gang. W8JO says drop a postal to State Highway Dept., any state, for state maps. W8FOV is taking haywire outa rig! No. W8CUX, the "3.5" talk you hear nowadays is about megacycles, not BEEF. W9GQF wonders if W9DCN and W9HIS still go for the "Gossard Blondes" up his way! Ye SCM is very glad to see the U.P. gang respond in such a fine manner. W8FAV found a YL almost as clever as mine! W8ICX is gonna be knifed! W8PP has the usual pePPiness. W8DZ is close second. DARA still seems to lead the Ontario section in Traffic Contest. W9GJX isn't walking the floor with the Jr. operator. W8BRS is 56 mc. "foney," sezze. W8FTW is going cahoots with Peeping Tom. W9LJH squeals on W9DAB for sending 15 rubber-stamp "88" messages to YLs! W9CSI with 100 watts in anuty calls 100 furriners and still has nix! W8DVC's YF has gone to country for summer. W8AEQ told W8ERQ who to total 'em. W8IFQ had his crystal cut in two pieces. W8DHC has buncha nice letters of thanks for his quake service. "Rebuilding, azzever," sig Bill, W9EGF. W8CET is new uncle due to W8WO's influence. W9FSK is glad to know that he has a new YL. W8BBP told us—heh. W9HK is reposing peacefully under depression. W8BMG is working up his A.A.R.S. group on 1.75 mc. W9BBP is quarantined for thirty days with Scarlet Fever! W9VL writes report with left hand; has a broken right arm. Traffic: W8PP 790 DZ 680 AEQ 512 FX 397 DFE 363 FTW 268 AYO 255 CEU 216 EVC 198 QT 167 CST 158 FAV 148 DWB 140 JX 125 DYH 124 CPY 104 EHD-RGY 103 FWT-DLX 86 BGX 84 IDB 76 AW 65 DHC 62 BHH 50 HZO 47 DVC 45 GBB 40 ARR 37 BTK 35 DUR 33 GRN 32 COW-BMZ 29 KJ-JO 27 GQB 26 BJ 25 HOT 24 HUD-HBZ 23 EGI-DED 22 IFL-ICX-GQS-BJG 17 CPH 16 EDO 15 FRW 14 GRB-BDH 13 IFQ 12 HQB-AJL 11 WR-BJT 10 GDR-CFZ 9 UD-IAR-HPH-BIK-BAW-CSG 8 HZY-GQQ-CUX-CUP-BIU 7 HL-BXJ 6 GUN-ERQ 5 FRF-FEE-DSQ-BRS 4 FVP-FTV-FQD-EGX-ECG-DXY-CTD 3 IN-IFE-ECG-DMR-CFM-AKN-AFH 2 SS-WOUC-NQ-HSH-HNQ-HKT-GMB-GG-FOV-DCQ-AAF 1. W9BBP 190 HXB 143 HK 122 YX 61 DSJ 55 CE 54 DQT 38 EVI 34 HSQ 30 DCN 27 GQF-FSK 25 ADY 17 LGU-IQC 15 IJH 13 EEM-DAB 8 CSI 7 EGE 6 IHM 4 EQV 3 GJX-GWR-CGX-AAM 2 LDC 1.

INDIANA—SCM, Arthur L. Braun, W9TE—W9ZZBO-W9JHY uses both calls. W9JRK will continue to operate. W9DHSJ says "all quiet." W9HTP is collecting parts for c.c. rig. W9AUT is ready for schedule with W9YB. W9DJU is pining the loss of '66s. W9HUO was visited by W5BUX. W9CKG worked a K5. W9DZX works plenty DX. W9FUT has new job. W9JHQ has several schedules. W9CRZ gets out best on 7 mc. W9JRR is ORS. W9FQ and W9ETH moved. W9LKW is new call of Ft. Wayne Radio Club. W9DPL has moved to Valparaiso from Huxley, Iowa. W9DJJ has c.c. rig. W9AXK is going c.c. W9CRD DX's. W9AKJ is active OO. W9CKB will be on soon. W9JKK worked ZL, EAR, HC. W9TE raised a V08. W9JXE is rebuilding. W9IMT plans on going to 7 mc. W9ADL has an addition to his family. W9GFS says the R.I. will visit Evansville. W9AET expects to run up a nice score in QSO party. W9FRV joined the St. Joe Radio Club. W9CWE is going back to TNT. W9BQH worked FM4AB for 44th country. W9DXH put up 4 ants. since Jan. 1st. W9LCU is trying 7-mc. zepp. W9YB has Comet Pro. W9BDE changed to class B. W9HSD put in c.c. W9AEA operated with r.a.c. note. W9HBK keeps schedules wid '28. W9FIY has 1.7-mc. 'phone. W9CTT was CYW from 23-29. W9HKY worked VK and EAR. W9ESU spends 95% of his time handling traffic. W9D00 is getting ready for exams. W9AJX has all kinds of trouble. W9KYM has schedule with XYL at W9ILH. W9GGP expects to rewind transformer. W9DEK is going strong. W9GGZ wants dope on A.A.R.S. W9JZF will be on about Christmas. W9AHL is coming on 3.9-mc. 'phone. W9ARK is blasting away. W9ELX is on 7 mc. W9JP will be on soon as gang gets station arranged. W9HTX moved to better location.

Traffic: W9FUT 606 YB 239 AET 100 HBK 69 IMT 74 DHJ 58 FQ 29 GHY 44 LLV 19 GFS 32 MM 12 HIU 11

AXH 10 AIP 11 HPQ 12 EXL 13 RS 15 JOQ 8 HML-  
HKH 7 GGJ 5 FRY-HUV 2 AUT 3S CKG 27 AEB 1  
JHQ 61 CRZ 22 GNY 11 CTT 54 ESU 46 KYM 34  
KPN 12 LNH 2 TE 23.

#### DAKOTA DIVISION

**NORTH DAKOTA** — SCM, Wm. A. Langer, W9DGS-  
LFW — W9FIV originated North Dakota's GRP  
message. W9HJC enters BPL. W9EGI is new TLS.  
W9EIG and W9AZV were visitors at W9FIV and  
W9GER. W9CVV is active 'phone. W9KZL finds 14 mc.  
FB. W9JOY is new in Bismarek. W9DHQ seems un-  
affected by the depression.

Traffic: W9DGS 659 HJC 503 EGI 322 DPT 79 FIV  
59 DYA 13 KBE 11 GER 9 JZJ-BTJ 5 JAR 4 IGR 3.  
**SOUTH DAKOTA** — SCM, C. B. Miller, W9DKL-  
W9GHO — W9DGR and W9IQZ, RMs. Flying and Wx  
forecasting at W9CFU. W9GYG is grinding crystals.  
W9FDD is building Autodyne receiver. W9LDU and  
W9GPB joined A.A.R.S. Aberdeen Amateur Radio As-  
sociation announces hamfest for June. W9IDW did well  
in DX contest. W9HAT worked K6ALM on 3.9-mc.  
'phone. W9GTG worked all districts but first using 2  
watts input. W9EBG took Comm'l and Amateur Exams.

Traffic: W9DKL 360 AZR 232 IDW 167 FDD 120 DGR  
101 HAT 99 GTG 85 FOQ 30 IQZ 27 EUH 24 JLA 13  
ALO 9 FLO 8 GLK 4 IGO 4 HSY 1.

**SOUTHERN MINNESOTA** — SCM, Norman Beck.  
W9EPJ-CGR — W9JID wins traffic banner this month.  
W9BN, LN, FCS, EFK, FNK, GLE, GNU, CKU, HMV  
and DMA handled earthquake traffic. W9CSY recom-  
mends the Jan. QST receiver. W9BKK is looking for-  
ward to Convention. W9EPJ is awaiting license renewal.  
W9BKK is rebuilding. W9BHC moved to 7 mc. How  
about ORS. W9CGN? W9CPP is building new freq.  
meter. W9JBA has new power supply. W9BLG reports  
FB total. W9JMV is adding P.P. '10s. W9DH handled  
GPR traffic. W9BNN, JBA, AIR and CTW visited La-  
Crosse and Winona. W9KDI is Secy. of Northfield Radio  
Club. W9EYL is in new QRA. W9HZU says "spring  
fever." W9FWN has 250 watts.

Traffic: W9JID 1122 BN 1117 CSY 703 LN 571 BKK  
287 EPJ 272 BKK 242 BHZ 197 FCS 169 EFK-GCN  
125 AIR 85 CPP 81 FNK 77 GLE 61 JBA 45 BLG 44  
JMV 40 GNU 38 DCM-HCW 33 DH 32 CKU 31 DRG  
29 BNN 26 CSU 25 HMV 22 DGE 16 CYA 13 KAV 10  
IAE-JHG 6 KDI 5 KKM-FMA 3 DHP-DMA 2 JQA 1.  
W9EFK 14 (Jan.-Feb.)

**NORTHERN MINNESOTA** — SCM, Palmer Ander-  
sen, W9DOQ — W9EGU worked VK. W9IPN is looking  
for dependable schedules. W9GRH worked little DX.  
W9AEL says it's tough to be broke. W9JIE recently was  
unable to keep a nearby schedule so he hooked a Seattle  
station, who in turn got the scheduled station and traffic  
was successfully handled in this three-cornered manner.  
W9BBL handled GPR message. W9CGN worked Irish  
Free State. W9DJW and HZ handled several California  
quake messages. W9FNQ reports. W9BRA has a couple  
prospective hams going in for exams. W9FTJ has perma-  
nent ticket. W9ISA is building new receiver. W9JLL  
promises better reports. W9IAA took exams for perma-  
nent ticket. W9HDN is putting '03A on air. Inasmuch as  
your SCM has been unable to give the time needed to push  
things in Section, he is petitioning and asking that you get  
busy on nominating petitions.

Traffic: W9IPN 41 GRH 16 FGJ 1 BRA 51 DJW 3  
FNG 39 IPA 7 HZ 116 DOQ 11 BBL 10 FNH 6 JIE 127  
AEL 23 KJT 4 JLL 44 FNJ 1 LAY 3 HDN 12.

#### DELTA DIVISION

**LOUISIANA** — SCM, W. J. Wilkinson, Jr., W5VVF —  
W5CTO wants schedules. W5BPL QRT. W5CEN  
was in DX contest. W5BYY and W5AXU are on. W5BYQ  
causes QRM. W5BANQ is at W5YT. W5WVG and W5EB  
have s.s. supers.

Traffic: W5EB-WF 168 BYX 101 BZR 40 AYZ 18  
CTO 16 IN 15 AFW 43 ACA 15 YW 14 AOO-BS 10.

**TENNESSEE** — SCM, Fremont F. Purdy, W4AFM  
— W4HA, AFM, RO, EX and BOZ turn in FB reports.

W4RO, BBT and BQK handled California earthquake  
traffic. W4ZZ handled daily messages for three weeks with  
W9KOV regarding a sick friend's condition. W4PL has  
filling stations posted for originating tourist traffic.  
W4AAO uses the same scheme in hotels. The East Ten-  
nessee Amateur Radio Assn. has a membership drive on.  
W4ADX built an SS receiver. W4BRU visited the SCM.  
New hams heard from: W4BUC, BUX, BVP, BRU and  
ADI. W4AYV qualifies for ORS. W4AAD is having suc-  
cess with matched impedance antenna. W4ADX helped  
design and erect it. A state bulletin will be issued to  
those reporting activities each month so be sure to mail  
in your dope each month on the 16th.

Traffic: W4HA 370 AFM 326 RO 191 BOZ 102 EX  
101 PL 88 AAO 74 BBT 44 AYV 39 OV 30 BUD 20 AXO  
12 ZZ 13 BFH 9 BQK 17 BUH 2 BGQ-ATE 1.

**ARKANSAS** — SCM, H. E. Velte, W5ABI —  
Traffic: W5BBI 601 AAJ 50 PX 109 CEP 20 ABI 57  
IQ 268 ABL 8 BUX 59 BZK 9.

#### HUDSON DIVISION

**EASTERN NEW YORK** — SCM, R. E. Haight. W2LU  
— W2CL reports many off-freq. stations. W2BZZ  
is high man. W2BJA reports real traffic stations lacking  
in Western N. Y. W2BLU handles line traffic. W2LU is  
QRL VCR. W2ENC is FB OBS. W2BSH is back on 3.5  
mc. W2ANV gives his total a boost. W2ATM reports  
new station, W2EZW. W2DZY is QRL STAM. W2BYR  
contacted Ship WTEP. W2DDW applies for ORS.  
W2ENR is on 5530 kc. W2CJP is using c.c.

Traffic: W2BZZ 537 BJA 477 BLU 302 LU 255 ANV  
239 ATM 186 DVY 74 BVR 54 DDW 26 ENR 25 CJP  
24 AN 19 QY 10 CTC 9 DWO 6 SZ 5 ENY-EGF-DQT-  
KW 4 EZO-CJS 1 ENC 234 UL 41 CFU 2.

**NORTHERN NEW JERSEY** — SCM, Walter A.  
Cobb, W2CO — Bloomfield gang gave farewell dinner on  
March 28th to W2VQ, who has been made general super-  
visor of the Eastern Division, American Airways, with his  
headquarters at Detroit. Mears has been a hard worker  
for ham radio, and will be greatly missed by the fellows  
from this Section. W2CWN excites pair '52s in final.  
W2DOU rebuilt for 1.7-mc. 'phone. W2DEE worked first  
EAR. W2DCE has new bug. W2CEC has construction  
permit for new super. W2EMY rates the local title of "Mar-  
coni" around Paterson. W2CNW swapped 50-wattter for  
pair of '10s. W2DOV uses d.c. receiver. W2DNX works  
West Coast with '01As. W2BEN is saddlebur under  
PCARC. W2EEC eats up all code practice. Warren Point  
is QRA of W2DRN. W2BRY is assistant op at WODA.  
New ham in Waldwick, W2FAF. W2PAQ and AFC are  
handling auto traffic on White Horse Pike. W2AQN en-  
tered YL business. Northeast took away W2BQV 55-  
foot mast. W2BYM has 3.9-mc. 'phone. Toms River po-  
lice department accepted transmitter W2BOA built for  
them. W2AUC gets real results from 14-mc. 'phone.  
W2AUC purchased new gas bike. WSN is district QSL  
manager. UCARA-RVRC joint hamfest was huge success  
with 411 paid admissions. W2FL swaps lies when busi-  
ness falls off. W2DIU, TP and CJX were main outlets  
for earthquake traffic eastbound. W2ABT contacted 21  
countries during DX contest. Rumor of W2BLT going  
back to Japan.

Traffic: W2DIU 1659 JC 79 CWK 62 CIM 60 BPY 70  
ABT-CGG-EJK 35 AMR 34 CJX 20 DPB 18 TP 16 EIC  
13 CZT 7 DV 3 EIP 209 EKM 148 DRV 105 BCG 91  
BWZ 64 DSV 51 BXM 25 DYZ 22 CDA 21 BQV 17 CZP  
15 PR-CO 14 PSX-ALD 11 ELJ-BYJ-TETA 8 DUJ-EVD  
7 EOH-ETQ 6 CTV-AWR-DWR-DXM 2 CHH 1.

**NEW YORK CITY AND LONG ISLAND** — Acting  
SCM, E. L. Baunach, W2AZV — Quite a few in this Sec-  
tion handled earthquake traffic. FB! W2DBQ is on 3877.  
W2BAS and BGO hold the Section's night shift.  
W2DUP's c.c. oscillator is a howling success. Hi. W2EHE,  
EVA, EQV, ETG, EYB, and EYU are new hams. W2BYB  
will be off three months. W2CBB handled his traffic in  
one week. W2CHK is trying DX. W2DJP and DQK are  
A.A.R.S. W2EAF is Ch. Tel. in U.S.N.R. W2ELK and  
EVQ are looking for ORS. W2BXJ and W2CCD are on

1750 kc. W2EQK has a 50 c.c. W2DQW is ORS. W2BSR and UK were in DX contest. W2AIQ says not much on traffic. W2BKY, AGC, and BVT are on 56 mc. W2LB is taking a vacation. W2DOK, AZ, CE, ACZ, CTK, ST, CT, and AEH are on 3.9-mc. 'phone. W2AZV and BPJ hold schedules regularly. W2WP sends usual good report. W2CKS thanks COU and DFO for helping him move.

Traffic: W2DBQ 292 DQW 139 WP 122 AZV 111 BPJ 82 BGO 77 DJP 66 CHK 65 DQK 60 AIQ 49 CBB 39 DUP 36 CYX 23 BAS 26 CCD 20 CWP 18 DRG 16 ASG 12 D0G 10 AAK 6 CLM-FF-BEG 4 CUD 3 RZ-LG 2 HY-BRB-BMH-TI-CPY 1.

#### MIDWEST DIVISION

NEBRASKA—SCM, S. C. Wallace, W9FAM—W9BNT, W9DHA and W9FAM lead. W9AFD-IFZ is keeping things going. W9FUV wins the crystal in Midwest Division traffic contest ending Feb. 15th for having highest score in Nebraska. W9DMY is building. W9EHW is keeping a lot of good skeds mostly on 160 meters. W9DOH is new ham. W9DI reports CARA will meet at Crete April 5th. W9DCC did some good work handling California earthquake messages. W9DEC is going ahead with new transmitter. W9LFE turns in FB report. W9HTU handles nice bunch traffic.

Traffic: W9BNT 815 DHA 541 FAM 424 AFD 202 IFZ 22 FUW 140 DMY 87 EHW 68 HYR 52 DXY 51 BCX 43 EEW 5 EWO 4 ISJ 2 DEP 5 EKP 10 DCC 29 DHC 74 IFE 90 HTU 205.

KANSAS—SCM, O. J. Spetter, W9FLG—W9KG is going strong. W9GBP reports Engineers Open House FB. W9CKV reports W9GJT on again. W9IQV takes high honors in school work. W9GSK moved. W9BFI went to 3.9-mc. 'phone. W9YAB is coming on with 250 watts. W9HSN stuck to the key over three hours taking earthquake traffic. W9NL called CQ and raised 5 BCLs. W9BEZ, CUN, BGM, and AWP are working 14 mc. W9DVQ worked two VKs on 3.5 mc. W9FET worked four countries. W9DXS is experimenting with 1.7-mc. 'phone. W9AWR wants to know how to charge dry cell "B" batteries. W9BYM is putting on 1.7-mc. code practise. W9GUS is ORS applicant. W9BYV and W9IQI are rebuilding. W9CET is on 14-mc. 'phone. W9FLG's high voltage transformer breaks down. W9KDO has MOPA. W9CUF bought out W9BHR.

Traffic: W9KG 701 FLG 520 GBP 322 FRC 295 KSY 230 IOL 201 HSN 186 AWP 164 EQD 124 KCR 120 DVQ 122 BWP 102 CUF 94 DEB 87 NI 85 KDO 79 GRA 72 CKV 71 ICV 50 GUS 54 FET 52 COA 42 AWP 38 BEZ 35 BGL 33 CVY 32 BUY 29 PB 28 BYV 27 IPM 23 BYM-BTG 22 AWR 15 HWW 12 DXS 9 EFE 10 DMF 8 GCL 7 HL 5 LFN 4 ECF 3 FMX 2 IQV 1.

IOWA—SCM, George D. Hansen, W9FFD—W9BPG, RM. Thanks, fellows, for reelection as SCM. W9BWF leads. W9ACL, FFD, ABE, BJP, JSO, DTL, AFQ, IHO, and IO, handled lots of quake traffic. W9EPA is QRL schedules. W9BFL applies for ORS. W9GPF paid us a visit. W9DUN is QRL business. W9FYX is trying to get going on 14-mc. W9CYL schedules. W9CWG is QRL work shifts. W9DEA manages a few. W9HMM/KSK is arranging schedules with World's Fair. New hams: W9LTF, KNI, W9GXU and IPC send first reports. W9JMX reports. W9DPL is permanently located in Valparaiso, Ind. W9EIV is rebuilding. W9DFZ is on 14 mc. W9FZO and JMX report. W9AEW is still kicking.

Traffic: W9BWF 336 ACL 285 10 230 FFD 214 GXU 163 ABE 130 BJP 129 JSO 104 HPA 67 BFL-GP 60 DUN-FYX 51 CYL 42 CWG 39 DEA 34 BPG-FYC-HMM 24 ERY 22 DTL 14 GWT-AFQ-DMX 10 LCX 11 KEV 8 LEZ 7 CFZ-EOE-HOH 4 GPL 2 JKT 11 EIV 67 IHO 57 DFZ 51 FZO 12 GQI 13 FQG 11 BCL-GQE 7 JXA 6.

MISSOURI—SCM, C. R. Cannady, W9EYG—RMs: W9BMA and FTA. W9BMA leads state. W9CJR holds first in ACTIVITY CUP RACE. W9BMA, NP, BGW and FJV make BEL on deliveries. W9FEX is ill. W9JWI is second on at BMA. W9HON is QRL 3.2%. W9ENU is QRL work. W9LBB blew power transformer.

W9AOG, DHN, HNM, FWQ and AUC are QRL school. Following deserve special credit for splendid cooperation in clearing traffic from California earthquake district: W9HUG, JBV, HVW, HWE, EFC, FYM, IXO, FTA, HSZ, BAU, AIJ, DUD, GBJ, BGW, CJR, FJV, RR, GDU. W9LTN is portable of HUG. W9MAK is portable of EHS. W9RME, AWE, and LVA come back with 50-watters. W9DCD reports amateur interest dying out in his district. W9GDU and IGX are going c.c. W9FZJ's '10 went west. W9DCB takes DX interest. W9EL is expected to lead Missouri in DX contest. W9IJW is recovering from YL QRL. W9HUZ is back from East. W9CRM is QRL Rock Island court. W9LWG is new St. Louis ham. W9LLN, CCZ, and ILI are on 1.7-mc. 'phone. W9FAB is trying to sell out. W9LTH uses 1000 volts on '10. W9GSO is back after vacation. W9DGI is with us after two months in hospital. W9FSZ and GBC have new speech amps. W9HBJ is named "Silent Abe." W9AEX and FAU are frequent visitors at Hannibal Club. W9AHH-BYN reports for first time as op of U.S.N.R. station ELO with KUT and AQX. W9CGB and HWD are rebuilding. W9TA and KFL report c.c. FB. W9FQY is on for DX. W9COT is QRL new ticket. St. Louis has two newly organized radio clubs: Mount City Radio Amateurs and Amateur Radio Fraternity of St. Louis. Officers of the latter: GTK, pres.; GUQ, vice-pres.; LTH, secy.; and LLN, treas. The St. L. A. R. C. has very FB new shack. The SMARA fourth annual meeting was held March 26th with following new officers elected: W9CJR, pres.; IXO, vice-pres.; EYG, secy.-treas.; and HUG, traffic mgr. W9GCG and W5BED were among new members. W9ASV renews ham activity.

Traffic: W9BMA 450 CJR 330 NP 321 BGW 304 FJV 206 FHV 185 AIJ 172 RR 127 HON 113 EFC 110 BAU 80 ECE 73 HWE 62 JBV-FTA 58 GCG 44 GBC 43 HSZ-GDU 33 IXO 31 HUG 30 HVW 29 DLC-HNM 28 DUD-GBJ-LBB 20 CRM 18 FEH 16 LLJ-FNO 15 IGX-ENU-CFL 12 CJH-FYM 11 GTK-ENK-EYG-FYU-EHS 10 DGI-EWT 9 AUC-LLN-HCP 7 AOG 6 ZZ 5 AHH-JPT 4 EL-LTN-FZJ-BWX-BYN 3 BGS-COZ 2.

#### NEW ENGLAND DIVISION

VERMONT—SCM, Roy L. Gale, W1BD—W1C1Y is QRL N. R. I. W1C6V has induction-coil power supply. W1CBW uses '47 c.c. oscillator. W1EFC has much DX success. W1DQK is on 1.7-mc. 'phone. W1DHX has new shack. W1BJP and W1ATF assisted W1BD in a demonstration at school. W1EIS has portable W1FOW. W1EJK handled California 'quake traffic. W1DAQ joined the A.A.R.S.

Traffic: W1ATF 73 CBW 55 DHX 46 BJP 30 BD 21 BZD 22 AXN 7 CGX 3 EJK 2.

NEW HAMPSHIRE—SCM, V. W. Hodge, W1ATJ—W1UN leads! W1DNC used '01A with 7 watts input for GPR. W1DM is Army Control for Maine, N. H., and Vt. W1IP got back in traffic column. W1FCI keeps three daily schedules. W1BEO is trying for ORS. W1AVJ has gone c.c. W1FQM is new op. W1BAC is trying 14 mc. W1AFD, BHJ, AGO, FGC, EYF, and CVK are working 1875 'phone. W1ANS is keeping schedules. W1BHJ and W1AFD are trying 56 mc. W1TA has portable, W1FQV.

Traffic: W1UON 878 FEX 461 DNC 82 DMI 81 IP 62 FCI 33 BEO 30 SK 25 EES-AXL 6 CCM 11 AUY-EZT 2 BGL 5 BMM 1.

MAINE—SCM, John W. Singleton, W1CDX—W1BOF, APR, CDX, AFA and AFT handled California earthquake traffic. W1CRP handled GPR traffic. The Queen City Radio Club is sponsoring a ham broadcast over WLBZ every Saturday at 8:30 p.m. Traffic totals this month represent standing at end of first month of Maine Section Traffic Contest. W1BLI donated a crystal for prize in traffic contest. W1BJA is working for ORS. "W1CPT, DX, nuf sed."

Traffic: W1OR 298 EF 294 BOF 235 CDX 233 APR 171 CRP 160 CHF 153 APX 114 AFA 104 BNC 100 AUC 88 PB 78 CPT 51 DHH 46 AFT-EFA 44 DEQ 38 BTG 40 BJA 23 FNG 12 EOX 13 AQW-DRZ 7 VF 5 QH 4 CFG 3.

RHODE ISLAND—SCM, N. H. Miller, W1AWE—

WIBGM reports new ham, W1FTO. WIDBF and WIDKQ have gone c.c. W1EOF and WIGV handled quake traffic. W1FUB is new ham. WIDCR is going up for 1st class ticket. WIASZ reports 14-mc. DX FB. W1AGJ is building 3.9-mc. 'phone.  
 Traffic: W1GV 122 EOF 65 ASZ 50 BGM 23 DDY 16 AWE 12 BOS 8 CGO 3.

CONNECTICUT—SCM, Fred A. Ellis, Jr., W1CTI—W1CJD made around 4500 points in DX contest. W1BDI schedules W9USA, World's Fair, Chicago. Most of W1YU's traffic related to the earthquake. W1NE breaks through with traffic. W1ES had to QRT schedules. W1DOW says Bristol Radio Club was active in DX contest. W1EMV has portable W1FSR. The Taft School Radio Club played chess with W1DNC. W1BEM did well in DX contest. W1ADW had W1CLB and W1ATL keep watch during earthquake. W1BEW handled Long Beach earthquake traffic. W1BFS is getting ready to move to Shelton. The Norwich Amateur Radio Club held a successful hamfest Feb. 25th. W1QV gave a talk on QRM locaters. W1DMK, DBW, BYW and CNU joined A.A.R.S. 60% of traffic at W1EFW-W1EWZ was handled on 56 mc. W1UZ says the YL who pulled W1BMP out of the mud was W1CVD. W1DFZ reported because W1BQS bawled out New Britain gang for not reporting! W1BMP says if things seem dry on 3.5 mc., take a listen to W1AFB work W2WP! W1EAO put in an e.c. transmitter. W1TD lost his job. Conn. Brass Pounders Assn. is putting out a bulletin. Drop a card to the SCM, if you don't receive a copy.

Traffic: W1CJD 604 AMG 328 MK 318 DGG 259 BDI 198 AFB 170 YU 155 NE 147 AKI 135 ES 112 DOW 100 EMV 81 EAP 79 AUK 77 FTO 70 BMP 63 CIG 55 BHM 53 CTI 50 BYW 46 ADW 42 BFS 39 BNB 35 ERU 33 APW 31 DMK-DEP 30 EFV 26 AJB 19 UZ 13 FIP-QV 12 CNU 11 DFZ 10 BWM 9 EWD 7 DBP-AVB 5 FIE 4 GC 2 EAO 1 BEW 19.

EASTERN MASSACHUSETTS—SCM, Joseph A. Mullen, W1ASI—W1ABG is reorganizing schedules. W1KH made front page of newspapers with earthquake activity. W1VS resigned as ORS and RM. W1WV has an FB7. W1ABF handled three inaugural messages. W1AGA is RM for Eastern Mass. W1LM handles three trunk lines. W1ACH is on 1.7-mc. 'phone. W1BBY keeps Canadian schedules. W1BFR makes the BPL. W1DES reports Falmouth Radio Club putting on a hamfest May 20th. W1BZO is Boston outlet for Trunk "C." W1ASF just missed breaking the high total record for the Section by 9 messages. (W1VS is still the record holder with 1082.) W1BEF uses two 50-wattors PP. Eastern Mass. traffic men, please get in touch with SCM for reservations at convention.

Traffic: W1ASF 1073 BFR 501 LM 305 ASI 287 BZO 128 ABG 122 WV 84 BBY 81 BEF 60 DFS 54 KH 51 ACH 46 ABF 36 AGA 23 CHR-BMW 22 WU-JL-FGT 12 ME 8 AHK 4 EVJ 3 ETV-ALP 2.

WESTERN MASSACHUSETTS—SCM, Earl G. Hewinson, W1ASY-W1RIB—W1BCX is leading in traffic contest sponsored by W1OF. W1BLG, AQM, CHU and ZJ are preparing for summer QSOs on 56 mc. W1AZW is secretary of Berkshire Brass Pounders Club. W1BWR raised his traffic schedules to 25. W1EFM reports W1ES sick. W1POF is our first YL traffic reporter. W1DCF and BCX handled GPR traffic. W1BNL reports small size crystals work good. W1BKQ says B.B.P. going full blast. Every amateur in this Section is invited to listen to WBZ or W1XAZ on Wednesdays at 11:15 p.m. E.S.T. for the A.R.R.L. programs. W1AUQ took part in DX contest. The Worcester Radio Assn. has new president, W1UM, and three new members, W1EDH, EKK and Earl Leland. W1CJL and EOB are QRL school. The YL Radio Club of Springfield paid a visit to WBZA and W1BVR.

Traffic: W1BCX 178 BVR 119 AJD 107 EFM 95 CSV 83 FOF 66 CJR 62 ARH 61 AMI 51 DLH 44 DCF 34 CJK 28 BNL 27 ERS 20 BEG-BPT 21 BZA 18 ECE 17 APL 16 ASY-DCH-ESG 15 DVW-APP 14 EOB-FGP 12 ADF 10 DIE-EFQ 8 FNY 7 BPN 6 CIZ-FFJ 4 BSJ-ZB-CWP 1 OF 9 BWY 19 FAJ 5 AZW 44.

## NORTHWESTERN DIVISION

IDAHO—SCM, C. R. Thrapp, W7AYH-CKO—W7AVZ is QRX license transfer. W7ATN, ACP, ALY, CMD, AYH, JL and UQ are working 56 mc. The Nampa gang has organized FB club. W7BRD visited W6DDD-AVW in Salt Lake and found them snowed under with earthquake traffic. W7QC works FB DX. W7AYQ has new c.c. rig. W7CSW has YLitis. W7BDY works mid-west. W7BRY is on vacation. W7BRU says no luck in DX contest. W7AYP is ALT DNCS in A.A.R.S. W7CQX has the measles. Moscow gang had contest with W7AGD, CRL and AVD leading. W7BYW is DX Hound. W7JW is QRL B.C. station. W7CSP is new Hamlette in Boise. W7BAR has new superhet. W7AVP applied for ORS.

Traffic: W7BAA 67 BCU 58 NH 30 BLT 20 AFH 18 CRL 16 AYH 14 BRD 13 AGD 12 BLL 10 JY 5 DD-CHN 4.

MONTANA—SCM, O. W. Viers, W7AAT-QT—W7AAT/COX worked overtime on earthquake traffic. W7ASQ handled GPR messages. W7AFY has a condenser trike. W7BAY rebuilds. W7BIZ likes traffic. W7CCR is ORS. W7CHW has SW3. W7CNE has YLitis. W7CRH works K6 and K7. W7BVE has new transmitter. W7BOZ is president of Great Falls High School Radio Club, W7BQG vice-pres. and W7BLA secy.-treas. W7CTP is new Anaconda ham. W7BCA works east. W7AHU has dead receiver batteries. W7BTL will soon have c.c. W7AYR is building a.c. receiver. W7AOH is awaiting new tens.

Traffic: W7AAT/COX 630 CRH 492 BVI 274 AQN 169 ASQ 134 CCR 63 BMX 81 FL 48 BVE 36 BOZ 33 AKM 23 AOD 15 AFU-HP 10 CEG 8 BDE 7 BHB-BJZ-BQG 6 COY 8 CME 3 BDJ 2 BUG 1 BKM 9 AFS 81.

OREGON—SCM, Ray Cummins, W7ABZ-W7CBB—W7LT leads the state. W7CWH, CUQ, and CTR are new Coos Bay stations. W7ZZZ has new sky-wire. W7AYB, and IF have good luck on 56 mc. W7BGF has c.c. trouble. W7QW makes ribbon mikes work. W7ANB and APJ are building Class B modulator. W7CIL is going to move his station to jail. W7CAE, BGG, BRH, and AKW are c.c. W7AUD is suffering from depression. W7AOL is blessed with a quiet location. W7CTE is impromptu O.O. W7ALO, and AEH are going hi-power. W7EN is earning a living. W7KR, and BDN are on 7 mc. W7BKD has FB signal. W7AIP has new transmitter. W7CSX is new Pendleton ham. W7AQX's 14-mc. 'phone gets out FB. W7MQ was heard in Poland. W7BEE is receiving QSLs without being on air. W7PL and BMW are QRL spring farm work. W7AHZ, CIS, BAX, BQK, and CBB are on 1.7-mc. 'phone. W7CVI is new to Oregon gang. Ex-W7AUJ and AIN are operating ZZAK. W7ABD, and AGT handled traffic. W7CQO, and ZZAE have '46s in finals. W7BHT is back on the air. New officers of RCARC: pres., W7ABZ; vice-pres., W7BTS; secy., W7ALA; treas., W7QY. Visitors of the SCM: W7LY, BFY, PY, AQY, and CNV. W7BMR is confined to low power. Portland c.c. stations: W7BXU, BYC, CCU, W7UM, AVV, VT, AKY, CDG were QRL earthquake traffic. W7AJM blew rectifier tubes. W7BBA, BOO, BDR, and AXU are rebuilding. W7AES, and BDK worked a lot of DX. W7CLW is back with the gang.

Traffic: W7LT 410 SO 196 AWV 192 WR 181 AJV 173 KL 174 ED 162 CEJ 137 AXJ 114 ABZ 82 ASG-UJ 81 PK 73 AIG 83 AHJ 55 AOI 56 AMF 43 BTH 32 BO 31 DP 29 QY-AWI-HD 21 CK 20 CRN 19 BMA-BWD 15 CBA 13 COU 11 CFM-BEK-AYU 10 BLN-AYN 9 MF 8 AID 6 ANX 4 BDU-BUF 3 WL-BOH 2 AJX-AZJ-BGG 1 GFO 18.

WASHINGTON—SCM, John P. Gruble, W7RT-W7ZZZ—Following have totals over 300: W7BHH, HS, IG, BB, and BSX. W7BZC is interested in starting a club at Puyallup. W7BYR celebrated on his nineteenth birthday. W7BGL contacted a W9 on 1.9-mc. 'phone. W7BGE clicked OH5NJ. We hope W7VO has recovered fully by now. W7CPD left for a month's visit to L.A. W7CIC is rebuilding. Quake traffic handled by W7BUK, CPK, QI, IG, RT. W7AAZ sends dope on Vancouver. W7OM is on 1.9-mc. 'phone. W7CPC will soon be on three bands. W7AIT and AHQ handled Washington message in GPR.

ORS renewed: W7SL, TX, HS, and BCV. W7CTX is new ham at Clarkston. DX is good at W7ALZ. W7CHY is using portable, W7CPG. W7ALE has doublet antenna and s.s. receiver. W7CAB uses pair '10s. Two '01A tubes at W7CHZ clicked VE3. YLitis for W7BZK. 1.9-mc. 'phone for W7CQJ. W7BBY reports traffic for the Spokane gang. FB! W7ACM is trying 14-mc. 'phone. W7AUN is QRL social activity. W7CJC is now low power. W7AHO returns to hammering after QSKing the YLs. Remember, gang, May 16th we want over 200 reports. COMING, JUNE 10th-11th; INTERNATIONAL FIELD DAY WITH WASHINGTON FULLY CO-OPERATING. GET THOSE PORTABLES GOING NOW!

Traffic: W7BHH 322 CFD 45 CNS 3 EH 12 QI 285 APR 25 AHQ 161 JF 38 BTM 13 ANN 39 CDC 31 CFY-BBY 23 AUI 19 AHT 10 CHU 9 BEV-CNC 8 AGO 7 CHV 5 AJJ 3 COZ-CBJ-BUY 2 CCF 6 ROC 8 BDW 6 ACS 46 LD 21 GN 11 CPF 13 CIA 3 CLJ 10 AQJ 5 BPO 2 CNZ-AWY-BBK 7 CEL 8 IG 367 BFL 15 BUK 23 BCC 38 AGV 37 CPD 15 AAF 10 BKE 147 AJ 41 CND 15 BIW 40 BYB 55 AQ 81 US 19 AYC 10 BUX 3 AIT 3 ZZR 32 ABU 8 HS 354 BWS 30 AFO 66 BLX 32 WY 397 APS 13 BZC 8 AEA 19 BB 322 BSX 389 AYO 21 AVM 27 CHH 101 CJS 10 RT 47.

ALASKA — SCM, Richard J. Fox, K7PQ — K7LW has gone to Cape Lisburne to operate K7AZ. K7BFO turns in fine total. K7ATO is QRL cannery. K7CPX is new at Wasilla. K7BFO visited K7BPD and K7MN. K7BPD is using his station in Aurora experiments at Alaska Agricultural College. K7CKT has an '01A. K7CCL is working lots of Alaska schedules. K7BNW schedules K7ATD. K7BZX returned from trip to the States. K7AVU is new at Ketchikan. K7ANQ joined the Army Net. K7FF says a snow slide hit his pipe line and broke it. A mile hike into the mountains on improvised snowshoes to the dam enabled him to turn off the water and repair the damage. K7PQ works Army Net under call WLVQ. K7BMY has accepted job with Airways. K7VH puts out a husky signal. K7ARL is overhauling a boat at Ketchikan. K7CCL's only DX is "J." K7ANQ hit the 100 mark.

Traffic: K7FF 379 BFO 374 CCL 195 LW 107 ANQ 101 BNW 93 VH 86 PQ 79 ATF 56 BND 50 COF 49 AT 37 BOE 26 BWQ 20 TF 7.

#### PACIFIC DIVISION

SAN JOAQUIN VALLEY — SCM, G. H. Lavender, W6DZN-W6WJ — W6BRV has highest traffic score ever made in this Section. W6BVM is proud daddy of a YL. W6FFP is proud daddy of a Jr. op. W6BKR and W6ENA offer the only means of communication with the prison road camp. W6EXH has 7 daily schedules. W6CCW has c.c. W6A0A handled important quake traffic for the Governor. W6BJE handled traffic on 'phone. W6ENH was active during the earthquake. W6DVI had a QSO with W6FLS, who is in China. The Modesto Radio Club had an FB ice-skating party. W6FYN wants traffic. W6AGQ is shooting for ORS. W6GEG changed QRA. W6FBQ is all set for traffic. W6AOZ visited the RI. W6BFH has a super-powered rig. W6BEXB ditched CW for 'phone.

Traffic: W6BRV 1822 EXH 383 DZN 306 CCW 241 DQR 158 AOA 165 BSE 113 ENH 109 DVI-FFU 90 FNA 86 AME 78 FYN 44 CVA 34 GKE 43 AOZ 40 BUZ 33 GSO 32 EPQ-DQV 26 AGV 23 FZA 21 GXE-CVT 16 BIL 12 BNH 8 COL 12 ASQ 3 GIV 2 GQZ 1.

PHILIPPINES — Acting SCM, Newton E. Thompson, KA1XA — Three more c.c. transmitters this month, KA1PS, 1NE, 1JR. Hope to have all P.I. c.c. by end of year.

Traffic: KA1HR 995 LG 226 CO 135 JR 134 NA 121 XA 68 PS-SP 27 KA9WX 67 EP 34 OMITB 525.

SAN DIEGO — SCM, H. A. Ambler, W6EOP — W6BMC is c.c. W6DQN handled quake traffic. W6GVU handled 400-word message from KA1HR. W6EJU and W6FGU were on the relay net between San Diego and Long Beach. W6FQD was second op at FGU. W6FWJ has new transmitter. W6BAM had two transmitters on the air to handle quake traffic. W6GAZ is in LaJolla. W6EFK and W6BMC called on the SCM. W6AXV has

a new Jr. op. W6BOW and W6AMO helped with quake traffic at W6EOP. W6FQU has new receiver. W6CNB handled first message from the quake area. W6CTP sent quake news flashes to W9FKC. W6BAS wants freq. meters to calibrate. W6DKN moved. W6GNL bought out W6DFU.

Traffic: W6BMC 837 DQN 644 GVU 411 EWU 310 FWJ 234 BAM 183 EOP 106 GAZ 103 FGU 110 BFK 71 AXV 55 BOW 43 FQU 37 CNB 34 DHP 23 QA 21 CTP-AXN 19 ACJ 15 CNK-BLZ 14 AMO 13 FQO 10 GNT 6 BCF-CNQ-AKY-LD 2.

EAST BAY — SCM, S. C. Houston, W6ZM — CRM, J. H. MacLafferty, W6RJ — Much credit is due the gang for FB work in handling earthquake emergency traffic. Special credit is due W6HHM, W6RJ (WLVR) and W6BPC (WLVF) for standing by for long periods to keep channels open. W6AF made BPL on quake deliveries. W6EDO comes back to life. W6FAC (WLVE) and W6CDA handled much quake traffic. W6YM's new transmitter is nearing completion. W6LY sends first report. W6ABE built a 2 x 4 shack. W6HLR is new ham. W6AUT sent his mother a wire via WU to LA the day after the quake, and she had not received it after 5 days; he went home at noon on the day after and QSO'd LA and got an answer in 5 minutes. W6AKB is building c.c. job. W6ANS-AHI is installing pole pig. W6FTI reported by radio. W6APB's house burned down. W6CAN is awaiting cooperation on 56 mc. We welcome W6AN as our new Director.

Traffic: W6HHM 796 RJ 513 BPC 436 AF 384 CDA 291 EDO 183 FAC 117 YM 113 IY 74 CIZ 37 TI 31 CSV 30 DHS 29 DKJ 28 BUX 23 CTE 18 EJA 17 EYC 16 AUT 4.

SAN FRANCISCO — SCM, Byron Goodman, W6CAL — W6PQ BPLs. Earthquake traffic BPL for W6BTZ. W6BVL's fine work runs up good total. '66 went west at W6EQA. W6ABB collected his in five days earthquake stuff. W6CIS holds down his end of the TL. W6MV did fine work with K6BAZ on HU-SF pentathlon. Long Beach disaster traffic at W6ZS. W6FPU did splendid work during earthquake. W6DZZ says Jan. QST receiver the berries. W6DNC's YF doesn't object to ham radio! W6SZ is out for "real" DX. W6BMK reports "catch as catch can" traffic. W6CIS schedules W6EXH. W6AZK had "neutralizitis." W6CAL quadrupled his 28-mc. output. W6FVJ observes 1000 volts on '10 has its bad points. W6IU worked K6BOE in pentathlon relay. W6GPB says too much competition on 7 mc. Earthquake traffic at W6GKO. W6WC complains of QRM. First report from W6DZQ in two years. W6HIR is new reporter.

Traffic: W6PQ 1424 BTZ 742 BVL 302 EQA 232 AB 165 CIS 161 MV 158 ZS 105 FPU 80 DZZ 73 DNC 59 SZ-BMK 33 GIS 32 AZK 31 CAL 30 FVJ 24 IU 23 GPB 18 GKO 17 WC 13 DZQ-HIR 10 AAR 8 BIY 7 EY 5 GWW-EKQ 3 GNX 1 NK 238 DQH 58.

SANTA CLARA VALLEY — SCM, Bruce Stone, W6AMM — W6FQY, FBW, DBB, BMW, BRW, CDX and YX deserve congratulations for the wonderful way in which they gave their time clearing messages for the earthquake area. W6HM delivered 106 TP messages. W6FUJ has 250-watt rig going. W6YX is new station of Stanford University Radio Club. W6DNY says '45s not so good for DX. W6BDR is coming up in traffic. W6DJP increased power to 50 watts. W6CNI got his total in four days. W6ALW gets fine results from '03A. W6UC scheduled AC2RT. W6EE received a report from Poland. W6DSE is running all stages of his 50-watt c.c. rig from an '80 rectifier. W6ENF is working 56 mc. New reporters: W6YX, BDR, CNI, EEH, CNN, GZP, YU, CW, AJZ.

Traffic: W6FQY 631 DBB 370 FBW 346 YG 332 HM 301 BMW 100 AZC 84 FUJ 78 YX 73 YU 68 NJ 62 BRW 56 DNY 48 ACV 41 DEV-CDX 37 ENF 35 BDR 34 EI 30 DJP 26 FMT-FBF 23 CNI 22 YL-AMM 20 CW 15 ALW 12 UC 10 DBQ 8 DSE 7 EEH 6 CNN 4 GOZ 1 GZP 2 W7CST 3.

LOS ANGELES — SCM, Francis C. Martin, W6AAN — Your new SCM wishes to thank the gang for the many kind wishes, and asks for continued support and interest which has kept us at or near the top during the past

year. Look at our totals this month. Twenty-six make BPL on totals! with five more on deliveries! The earthquake gave us a lot of good items, but it is regretted they could not be used because of space reduction. W6BYF led the list working from Legion Hall at Long Beach. W6EK makes BPL! W6AM was on with all three of his family stations. W6ABF was one of the first active 1.7-mc. 'phones in the emergency. W6GXM makes ORS and BPL. W6AUB worked portables in the emergency area and lost a lot of sleep. W6CJS worked 46 hours straight through on 3.9-mc. 'phone in the emergency. W6EZG lost poles in the quake, but kept on the air. W6DZK lost his radio store, but took to the air and helped out the traffic. W6FXR is working "Js." W6CES says 14-mc. DX getting better. W6CUH reports 152 DX contacts in the DX tests, and succeeded in working his 61st country. W6DEH got his 'phone ticket. The gang in Pasadena is pushing 56 mc., according to W6BOB. W6BWW is giving up c.c. for electron. W6DZP wants better traffic deliveries. To Hal Nahmens, W6HT, goes considerable credit for our big totals this month; he is still with us.

Traffic: W6BYE 2630 GJD 2000 GSR 1400 HAQ 1280 ETM/CQM 1263 GOY 1138 EK 1062 EDW 1046 FEX 952 DKM 841 GWX 800 FGT 798 ANU 769 EBK 760 BSV 723 ETJ 716 AM 770 DBC 695 BPU 678 HT 660 RO 605 ETL 603 GXW 570 AFO 550 EII 503 DLI 435 CVF 407 ABF 400 ERM 307 EQW 355 EGG 251 BZF 301 LN 275 AWY 261 BCT 263 GXM 259 HHU-EPE 235 AKW 230 FFN 224 NF 213 FUF 207 EZK 205 EGJ 203 AUB 195 BXU 191 EQM 190 EKZ 188 DEP 170 FYT 157 HEW-DOX 148 DH 147 FZK 142 EDZ 138 FYF 134 CJS 133 FBT 134 AIX 111 AMP-EGS 108 BGN 104 FZC 99 DYJ 96 ESW 90 CUZ 89 GGH 84 FNG-ZZA 83 OZT 82 BYC 80 AAN 79 FOZ 78 CVV 76 RZ 70 EZG 68 DJG 68 DJS 63 GKZ 57 BOB 50 ADH 54 FXR-BGF 52 BJX-FVD 50 CAH 45 YBB-CES 42 ERL-DVV 41 EUV 39 DSP-CLK 38 GQL 36 WO 35 DZR 33 CGP-EMJ 29 LY-ATG 27 EYJ 26 GMA 25 FJP-EMY-ELU 24 BWW-TH-DZF 23 EWY-ZBC-BDM-DZK 22 BER 36 AMQ-FWN-EOG 20 HAP-VJ 19 EJT-BDZ-ATG-HFG-GLV 18 FXL-FMP-DTX 17 FEW-FCK-BCE-FPP 16 CEV 15 FDM-GOX-BVZ 14 FSE-GZU 12 BWG 11 FSJ-BHP-ACL-EAT-FLY 10 ETX 9 EJZ-GSH-TN-FDO 8 DOP-FMO 7 EQJ-GNZ-CZW-GPX-DCJ-ESA-DQR-CWZ 6 MA-FJT-GEK-BRO-DOP-DLN 5 BPD-CUH-DYQ-ERU-GIG-GNM-EIW-PD-CLC-DEH 4 FMI-GFG-FXI 3 CLY-DWF-FJS-GWJ-DPG-DOK-DZI 2 GM-GMC-AGF-ON-CTZ-BWE 1 CVZ 152 EPC 928 GVV 21 GQG 132 CMS 23 AOR 700. W7ZZK 113.

NEVADA — SCM, Keston L. Ramsey, W6EAD.

Traffic: W6UO 835 AAX 62 GYX 40 GUR 32 ACU 16 BTJ 6 BYR 4 BIC 1 HCB 5 HCY 2.

SACRAMENTO VALLEY — SCM, George L. Woodington, W6DVE — W6GSP is working on 7 and 3.5 mc. W6GSS is rebuilding. W6FPH is going to high power. W6GUK is on 1.7-mc. 'phone. W6AIM is on destroyer KING. W6BHM reports for Paradise. W6CUM and BLW are on 3.5 mc. W6DGS is QRL college. W6FKM is building c.c. rig. W6GGB's antenna blew down. W6CRN pushes key at GBB's. W6AXM and DVE each handled earthquake messages. W6AHN originated the GPR message, which was routed three ways, W6BYB, W6DVE and W6CIS. W6BYB gave this message direct to W3AJP, Washington, D. C. W6CKO and DVD deserve special mention for relaying important National Guard and Red Cross messages from earthquake area. W6AXT handled important earthquake traffic on 'phone. New Sacramento stations: W6FER, GHN, GZY, and GDJ. W6EAG is building c.c. rig.

Traffic: W6CKO 196 DVD 137 DVE 129 BVK 86 AK 70 BYB-AXM 34 CIR 29 CGJ 23 GAC 22 FRP 19 ??? 14 FEJ 13 FW 9 EWB 30 ECW 8 GTZ 6 ENC 4 AHN 24 GVM 2 AID 30.

ARIZONA — SCM, Ernest Mendoza, W6BFJ-W6QC — Following stations handled important emergency messages during California quakes: W6DJE, CQF, BCC, BVN, DHR, BRI, ZZBC. W6CDU believes the hams that started things after first earthquake in California did

excellent work. W6FZQ is QSL manager for 6th district! W6BLP gets better results with a Hertz. W6GBN is a "nite owl." W6FIP will attempt "radiophone first." W6EGI was heard by BCLs all over town! Ex-W6EVM will soon be active. W6CEC is set up again. W6HKX is on 7 mc. W6EKX is rebuilding. W6AND was heard in Germany. W6EJN is on 3.9-mc. 'phone. W6EBP has a "shack." W6CKF has a powerful '52. W6FGO is on for A.A.R.S. W6EL schedules DJEL. W6BFA is active in Mess. W6CEW is in Phoenix. W6EKU is building a 'steen-tube 'phone heap. W6DPS is pounding brass from W6ACN. W6DSQ is poring over the 'phone exam. W6AEK is motoring back from Pennsylvania. W6FAI finds that Army field hand-generators have valuable non-military uses! W6FLG is on the road somewhere near his goal: Ohio. W6FEA has PP '52 job. W6GFS was in Prescott on business. W6GJC is placer-mining. W6EFC is driving a friend to Eureka, California. W6AYW had tube trouble. W6ELX-ILY may move to San Jose, Calif. W6GDI uses a super-het. W6GDF is on Sunday mornings for A.A.R.S. W6BYD is building QST TRF receiver.

Traffic: W6CDU 817 ZZBC 470 BRI 137 DHR 121 BVN 46 FZQ 40 BLP 37 CQF-GBN 23 DJH 19 GCU 16 HAX 10 CGL 9 BCC 6 GFK-HEU 5 HBR 4 QC-DOW-DRE 3 HBQ 2.

#### ROANOKE DIVISION

WEST VIRGINIA — SCM, C. S. Hoffmann, Jr., W8HD — W8CZ and W8EIK got the GPR message through. W8DPO and W8TI made high scores in the DX tests. New officers of Ohio Valley Amateur Radio Club: W8CDV, pres., W8ELO, vice-pres., W8DPO, sec.-treas. Radio club at W. Va. Wesleyan College has call W8ILY. W8FQA has portable W8ILZ. W8ASI is working 56 mc. W8BDD has an 8-pound junior opr! W8CMJ is our new ORS. W8CRJ schedules VKs, ZLs, and asks for traffic. Board of Governors for the Bluefield Amateur Club are W8ING, EIP, CDE, W3AAF and D. B. Gray. W8BOK visited the SCM. W8BCSF and W8EL have new outfits. W8BWK is QRL U.S.N.R. W8HWS is located at the Engineering Dept., Linsly Institute, Wheeling, operated by W8HWI.

Traffic: W8EIK 400 BWK 166 DPO 98 GB 91 CMJ 61 HD 59 CSF 56 EL 46 ELJ 24 ELO 13 HSA 14 OK 13 EWM 12 HCL 10 BKG 8 GRJ 6.

NORTH CAROLINA — SCM, H. L. Caveness, W4DW — W4DW, the retiring SCM, deeply appreciates the hearty cooperation and loyal support accorded him during his three-year tenure of office, and wishes his successor a still longer term of more notable achievements. W4ZH worked six continents in one day during DX contest! W4AVT is trying to get 1.7-mc. 'phone to work. W4AEH is putting a 50-watter in last stage. Every ham in the state sympathizes with W4ALD, whose wife died on March 6th. W4AAE, TR, DW and ATC handled California earthquake messages. W4BVD is new station in Warrenton. W4TR's 3905-kc. 'phone has been reported heard in England. W4AA is QRL U.S.N.R. One of the towers at W4NC fell. W4RA and W4OG have gone to 14 mc. W4BUO is new YL in Winston-Salem. W4TO made a good score in DX contest. W4CP is ready to start c.c. rig. W4BCG renewed license.

Traffic: W4ATC 175 DW 128 JR-TO 91 BRK 75 NC-TP 42 AAE 39 VN 37 ZH 36 TR 34 EG-TJ 33 AVT 32 NP 22 AIS-CP 21 ANU 19 BU 15 ALD-RE 16 ABW 15 RX 14 RV 13 BLN 12 JB 10 AL 9 BHR 8 AA-DQ 7 AMC-ADY 6 AGD 5 QI 3.

VIRGINIA — SCM, R. N. Eubank, W3AAJ-WS — S. T. Terry, Jr., W3CVU, Route Manager. C. E. Hedrick, W3WO, Asst. Route Manager. Following handled earthquake traffic: W3ATY, AZI, BSB, AAJ, GY, BPI, CNY, WM, BRY, BZE, BRE, AHC. These handled GPR messages: W3NB, AAJ, FJ, BZA, CXM. New traffic reports: W3EF, OM, ZA, APU, COJ, GZ, GLV, AG, APF, AZI, BZE, BRE, CLH, CPN, CVU, QN, RL, UVA. A.A.R.S.: W3GE, CVU. U.S.N.R.: W3QX, UVA, AVR. New stations: W3BXL, GZ, CYM, DAO, CUR, DDB, JG, CZX, DAR, DAS, BRE. Rebuilding: W3BWA, AGW, BXN. New non-traffic reports: W3CA, BRA, BZD, BBX, BFW, ASK, AU, AAR, BWA, BRK, CUR, CYM, DAO, JJ, NO, BBE. ORS coming: W3AIL, CHE, CDW, WO. Passed 'phone exam:

W3ADJ, BSM, AEW, W3AAR's QRA Big Stone Gap. W3JJ is in hospital. W3BPA's QRA 819 W. 42 St. W3CLD changed YL. W3BGS has 48' poles coming up. W3CKM has new antenna. W3CNY is OBS 1991-ke. 'phone. W3CLV married. W3AU has '52. W3NO's QRA 1707 Hancock Ave. W3BAN reports 1.7-mc. OO work. W3QN is back on air. W3AG worked ON4AU. W3BAD worked ZL. W3BAI conducts code classes, 1777 kc., Wed. and Sun., 9 to 10 p.m. W3BKS is trying low power. W3BFQ has new panel rig. W3AJK is at R. M. College. W3APF worked EAR18. W3ZA sends OBS, 3941-ke. 'phone. W3RL is lining up. W3BIW is experimenting. W3AMB hunted local QRM. W3AKN is d.c. crystal. W3TN sends good dope. W3HIV is QRL sickness. W3BNH is coming traffic man. W3AEI reports fast. W3CVN is Roanoke RM. W3BXA, APU, CLH, AAF are on 3.5 with FB success. W3NE, ASK blew tubes and BYP his crystal. If you report one or more messages to SCM W3AAJ, you will receive Virginia Bulletin with his compliments. Otherwise, 30 cents a year.

Traffic: W4NB 604 ATY 260 OM 110 BNH 105 BKS 93 FZ 88 AAJ 84 AII 82 FJ 76 BXP 41 GE-WO 39 BAI 36 CLV-GZ 22 GY 21 BPI-CKM 14 AEL-AGW 13 CSY 11 AAF-APP-BYA-COJ-TN 10 CNY 9 BIW-HV-QX 8 BZA 7 ADJ-AMB-BAD-BGS-CHE-COO 6 AG-AZI-UVA -WM-BRE 4 AKN-APU-BRY-BSB-CSI-BSY-BZE-CLD 3 CDW-CLH-CVU-QN-RL-WW-ZA 2 NE 1 CXM 461 CVN 31 MQ-AVR-AIJ-BRQ 2 AHQ 28 CAH 15 BUR 7 BSM 6 CFL 4 AJA 4 AHC 21 CMJ 18 AUG 7 CFV 4.

#### ROCKY MOUNTAIN DIVISION

UTAH-WYOMING — SCM, C. R. Miller, W6DPJ-W6ZZZ — W6BTX leads. W6AFN has new receiver idea. W6GPJ handled important traffic with California earthquake zone. W6FAE, EYL, APM, EZD, passed 'phone exams. W6DPJ entered DX contest. W7ARK is in California. W6GQC finished new receiver. W7CNT and W7CAP visited S. L. C. W6DGR has a new rig. W6BSE is trying unity-coupled rig.

Traffic: W6 BTX 217 AEN 117 GPJ 61 FAE 55 DPJ 52 FRN 42 HIE 17 AHD 12 DTB 3. W7COH 39 BFC 6 CDH 4.

COLORADO — SCM, T. R. Becker, W9BTO — A joint meeting of Colorado Springs and Denver gangs was held March 3rd. The Colorado Springs gang is having Denver, Pueblo, Rocky Ford, and Greeley to a hamfest March 25th. W8FIO is now at Woodmen. W9EYN, EHC, FXQ, and LFE handled many earthquake messages. W9HDI and EPN were leaving for the hills when the telephone started ringing with messages from everyone who had relatives on the west coast quake zone. W9DNP is taking bugs out of his multi-stage c.c. rig. W9DYP has one of the "swellest" notes on the air. W9JNV handled on the average of 75 to 100 quake messages a day. W9LJF is rebuilding. W9FYP built a velocity mike. W9AMS is QRL battery store. W9JCQ handled a few messages from the west coast quake. The Denver Radio Club is going 100%. W9ESA has the habit of making BPL every month. W9JB is on again. W9LJU is on 7 mc. W9LNB handled a bunch of quake traffic. W9GVN-FYG is QRL rebuilding. W9LYE is making all the 1-kw fones wish they had his outfit. W9CVE makes the BPL. W9ITE offers ten bucks ransom to the fellow who kidnaped his code machine. W9CJJ is operating at KFEL. W9HRI QSOed a carload of DX in DX contest. W9BTO will be on 7 mc. as soon as he gets new receiver. W9ERP is only Denver 'phone on 3.9 mc. W9AUJ is building BCL's short-wave receivers. W9MAQ is new Denver ham. W9RJ is working on new outfit. W9BJN is on with a pair of fifties. W9AAB is home after a trip east. W9FA is trying ranch life. W9FCB is on. W9LCM is at Huntington Park, Calif. W9BYK is ready to go on 7 mc. W9CBU is QRL hospital. W9CWX is putting out a nice signal. W9KGR is rebuilding. W9HIR is back on 14 mc. W9FYK is falling for YLs. W9IUH can't decide between "oscillating" and "osulating." W9FQJ is proud owner of airplane call, W10XG. W9EDM wants suggestions on building a vertical underground antenna. W9ZZT is new Greeley ham. W9PO has new rig. W9CKO changed QRA to Boulder. W9JFD is on U.S.N.R. cruise. W9KKY has new antenna pole. W9CKO is A.A.R.S. W9GPP let his ops license expire. Earthquake

traffic had W9BJZ going. W9ADR is working 7 mc. W9LWC is an OT. W9GNK handled GPR message from Calif. W9HHP is coming along fine. W9FPZ is at KGHF.

Traffic: W9JB 26 IJM 16 DGY 20 IJU 25 IPH 4 LNB 25 BYY 17 GVN 181 LYE 32 CVE 686 LFE 201 CDE 13 DQD 5 GNK 259 EII 4 IFD 13 CWA 12 EYN 350 JCQ 34 ESA 1226 GLG 11 JNV 631 DHI 10 BJZ 27 GLI 11 LQO 3. EHC/FXQ 100.

#### SOUTHEASTERN DIVISION

WESTERN FLORIDA — SCM, Edward J. Collins, W4MS-W4ZZP, Route Manager, S. M. Douglas, W4ACB-W4PCN, Thanks, fellows, for reflecting me SCM. The hamfest went off in great style in Pensacola. Mobile was represented by W4OA and W4BLL. W4AUW was awarded the "Wouff Hong." W4AGS-W4PCK is rebuilding. W4KB is getting out on low power. W4BPI is QRL school. W4BFD lost his antenna in high winds. W5ZZR is getting wed. W4QU has trouble with '04A. W4QK has new shack. W4ABK is our youngest ham. W4QA gets on. W4BSJ steps out FB. W4KB handled earthquake traffic. W4BGB is on 3.5 mc. W4BCB keeps his '52 hot. Ex-W4ASG joined the Marines. W4BKD moved into the house. W4BOW's shack leaks. W4ASV-W4ZZW hears many J's. W2EVB-ABC is oping for the Pan-American Airways. W3ADO visits Mobile regularly. W4UW-5NO is back in Texas. W4QR-PEL is active. W4AUA keeps the U.S.N.R. going. W4BMJ is trying to hook a W7. When W4ACB presses the key his whole shack oscillates. W4CV-W4ZZAE-W4ALJ has been visiting South Fla. W4VR has been busy painting autos. W4ARV says c.c. FB.

Traffic: W4BSJ 32 AGS 22 KB 16 ACB 15 BGA 2 QR 20 AUW 17 AUW 10 AQY 6 AXP 12 ZZA 2 MS 14 BKV 3. W6HET 6.

GEORGIA-SOUTH CAROLINA-CUBA-ISLE OF PINES-PORTO RICO-VIRGIN ISLANDS — SCM, Chas. W. Davis, W4PM — W4PM applied for portable call. W4ZZAN put the Ga. GPR message direct to Washington by 'phone! W4MN handled the S. C. GPR message. The Palmetto Radio Club of Columbia has reorganized, W4VL pres., W4CO secy. W4VL, GB and CO have been on 56 mc. W4DX is in charge of radio for S. C. Nat. Guard. W4MN is on 3800 kc. W4GB works 7200. W4ATZ wants ORS. W4ATZ is QSL Manager for this district. W4SS rebuilt. W4ZZAN, MO, MV, BGE, KU are on 3.9-mc. 'phone. W4HT is secretary of Atlanta Club. W4UT has moved. W4BQX is ORS.

Traffic: W4WZ 554 IR 205 ATZ 84 BQX 34 AAY 19 BW 7 BRG 6 MA 4.

ALABAMA — SCM, L. D. Elwell, W4KP — W4AAQ makes WAC. W4APU succeeds W4BOE as president of Birmingham Radio Club. W4BCV has Class "B" 'phone. W4DS has two transmitters. W4RS has SS receiver. W4AYK and BMM are on 1.7-mc. 'phone. W4ANT is an ex W9. W4BET is joining A.A.R.S. W4BSL is going OK. W4BSE is new station in OPP. W4BAI is working four bands. W4ADJ has TNT. W4BVH is new ham in Tuscaloosa. W5BOU was in DX contest. W4PDR is QRL U. of A. W4BJA is experimenting. W4ARR and AWM are installing e.c. oscillators. W4AJP and JX handled traffic from quake area. W4OA is on 3.9-mc. 'phone. W4FL is working A.A.R.S. W4AXU worked X1G, X1Q and HCLFG. W4ZS is getting out better. W4AP uses condenser mike. W4BTR had trouble with transmitter. W4BFA and W4PPT are active.

Traffic: W4AJP 160 BJA 58 JX 54 ARR 51 DS 46 APU 23 DD 11 AWM 12 ALA 9 BCL 8 AG 4 HO 3 BRX-AQC 1.

EASTERN FLORIDA — SCM, Ray Atkinson, W4NN — W4BRO, VP and NN make the 100 total club. W4ZV is QRL school. Lightning struck W4ZU's rig. W4BJS is c.c. W4DA has the flu. W4WS ('phone) sent in traffic. W4ACZ is active A.A.R.S. W4NN is building Class B modulator. W4UX has 1-KW input. W4AZB is busy O.O. W4BRO says skip bad. W4BGG handled traffic from California earthquake. W4VP keeps schedules. W4AS got married. W9UZ is visiting Florida. W9DAQ, W8IEJ, and W6ZZS are visiting Daytona Beach.

Traffic: W4VP 236 NN 130 BRO 107 BJS 34 AGB 20 WS 12 BGL-BAM 9 TK 7 BIN-BNI 6 BMN 1.

## WEST GULF DIVISION

**NEW MEXICO**—SCM, Jerry Quinn, W5AUW—W5GWM handled earthquake traffic. W5CJP did well on the GPR. W5AAX's OW is planning on starting a YL traffic net. W5AOP did duty at W5AUW during earthquake traffic rush. W5CSR was on. W5CPO is selling transmitter.

Traffic: W5AUW 657 AAX 54 CJP 6 BNT 10 AOP 50 CGJ-ZZQ-CDF 8 CWM 42.

**SOUTHERN TEXAS**—SCM, D. H. Calk, W5BHO—W5OW reports new transmitter on 14 mc. W5CXJ is on 1.7-mc. 'phone. W5BVG, PF and OR are building 1.7-mc. 'phones. W5YL'S hopes in DX contest were smashed by exams. W5NM handled about 55 messages from California quake. W5BUV reports new calls, W5AOL and W5CBM. W5BKE handled much traffic from and to California quake. W5ASM is Chief Engineer KFUL. W5AFV worked Africa for WAC. W5BTD is QRL new Jr. op. W5ADZ worked 7 different "Js." W5BKY handled traffic from quake. W5APX is rebuilding. W5ON built a 1.7-mc. 'phone for local work. W5BKW works 3.9- and 1.7-mc. 'phone. W5BZW reports for Corpus Christi.

Traffic: W5OW 1393 BKE 519 MN 376 YH 316 YL 38 ADZ 36 BUV 40 PF 16 BZW 13 TD 7 BKY 4 BQI 3.

**OKLAHOMA**—SCM, Emil Gisel, W5VQJ—W5CEZ leads the Section. W5BDX handled California earthquake traffic. W5BMU is SNC AARS. W5ALD has been QRL planting taters. W5CNC sends first traffic report. W5CRS and BDE are c.c. W5BRD polished up his '52. W5GA handles traffic on 'phone. W5AKX has nice schedules. W5BPM hasn't much time for traffic. A big joint meeting of the "Tulsa Amateur Radio Club" and the "Ponca City Key Clickers Club" will be held at Tulsa June 17th-18th. Let's turn out and make it a huge success! W5AUG reports DX picking up. W5ASW has a 50-watt c.c. rig. W5AVT is new member of Key Clickers Club. W5CXE, CWT and CXP are new hams. W5ABO is on occasionally. W5BLW is thinking of higher power. W5PP-W5AJO have been trying Class B. W5KX' license expired. W5BIM is on from W5TI. W5OJ works for Police of Wichita Falls. W5CBH is working 1.75 'phone and 3.5 c.w. W5BRT is on 3.9-mc. 'phone. W5VQ has rectifier troubles.

Traffic: W5CEZ 477 BMU 296 BDX 246 ASF 180 GA 162 ALD 112 CNC 62 AKX 44 BPM 35 BQA 33 BOE 32 CBY 26 BKD 9 CVA 8 GW 7 BAT-AYF 6 AVN 2 KZ 8 AND 9 AMS 60 ABK 24 CIZ 12 BWN 4 YE 20.

**NORTHERN TEXAS**—SCM, Roy Lee Taylor, W5RJR—W5IT and ANU handled much quake traffic. W5AUL devotes 40% of his time to traffic! W5BII has a good many schedules. W5BKH pounds his share of traffic. W5BVF has decided to get in the 100 mark with traffic. W5BCW is lining up with W9USA for all Texas traffic for World's Fair. W5ARS is doing good work in Wichita Falls. Your SCM offers a new '10 tube to the man making the BPL in next report. W5AMK reports for the Cen-Tex Amateur Radio Club. W5CCD is going in for traffic.

Traffic: W5AUL 370 CAV 84 ARS 184 ANU 87 IT 113 BKH 140 BVF 123 BJB 22 BNF 58 AHC 47 BCW 63 CBJ 52 BII 335 AJG 48 CGD 168.

## CANADA

### MARITIME DIVISION

**NOVA SCOTIA**—SCM, A. M. Crowell, VE1DQ—VE1BV is now c.c. three bands. VE1BC is going up for Comm. Ticket. VE1ER, VE1EX, and VE1DC are keeping good schedules. VE1AG is starting work on transmitter. VE1AL was heard in Louisiana on 3.9 mc. VE1CR will soon be high power. VE1AH is QRL. VE1CK will erect new sky wire. VE1BN's new 3.9-mc. 'phone gets good results. VE1EP got ORS. VE1DQ is on 14 mc. VE1AS gets out well.

Traffic: VE1ER 105 BV 19 CY 7 EP 3 BM 1.

### ONTARIO DIVISION

**ONTARIO**—SCM, H. W. Bishop, VE3HB—Regret to announce that VE3GT has resigned as RM. VE3HA and AD did important work in California quake. SCM and VE3HP paid Brantford gang a visit. VE3WX sends an urgent SOS for traffic and schedules. Hamilton

gang on 7 mc.: VE3JU, QD, QH and QE. VE3NC "Duplicate Drummondville" is nearing completion. VE3LY is new ORS. VE3JI works on Naval Net. VE3LM will soon be heard. VE3TM is ORS applicant. VE3GS got another 75-watter. VE3GB is worrying about 'phone. VE3CX put an antenna on a telephone pole, and next morning they put a 50-kw. transformer on it. HI. VE3SPY gets out well. VE3VF has a slew of 211E. VE3DX is heard on 14 mc. VE3HW is on 'phone. VE3HY wants a schedule south. VE3YY worked a VK. VE3GA is on with '45. VE3BO says it's only 56 below at worst at Red Lake. VE3QB has volunteered for QSL Manager Ontario. VE3NX is new rig. VE3CM is hard at DX. VE3GC has QRL. VE3KC is on 14 mc. VE3FD has FB 3.9-mc. 'phone. Ex VE3IA will soon be on. VE3WM changed QRA.

Traffic: VE3AD 766 WX 437 GT 243 DW 261 KK 260 QK 174 HA 160 JI 161 TM 138 HB 117 RO 75 LY 75 LU 44 WF-WJ 41 WK-HY 32 GX 31 OH 30 SA 29 OF 27 RT 25 IH 20 LI 15 HX 12 HU-NE 11 MG 10 JF-NQ 9 MH-MX 7 WA-AU 6 DD 5 EC 4 OE-LJ 3 JW 2 QB 1. VE3AL 15.

### QUEBEC DIVISION

**QUEBEC**—Acting SCM, John C. Stadler, VE2AP—VE2DL is c.c. VE2FE keeps traffic going. VE2BE has January three-tuber. VE2GE is a new ham. VE2EE, DR, AP went into DX contest. VE2DD has transmitter trouble. VE2AL operates VE9FG on 13,040 and 4760 kc., and wants ham contacts. VE2EU is still going. VE2AA will QRO his 'phone. VE2AB has '46 for modulation. VE2GM pounds mornings. VE2CP has several new operators. VE2AX and VE2FW are working 56 mc. Welcome to VE2GF and VE2GD. VE2CQ is busy in local contest. VE2CU is off until exams end. VE2CM and VE2HT are on the air.

Traffic: VE2BT 9 AP 103 BB 65 BG 35 CX 34 FE 76 CO 6.

### VANALTA DIVISION

**ALBERTA**—SCM, C. H. Harris, VE4HM—VE4BI is giving code practice. VE4BJ works South Africa and "J." VE4BV has new transmitter. VE4DQ handled GPR message from Alaska. VE4EA works "G" and "J." VE4EO tries 7 mc. VE4FR is pleased with new super. VE4GM is building 14-mc. 'phone. VE4GT works the odd station. VE4GY schedules the Arctic. VE4IZ handles wx reports for University. VE4EV is starting. VE4CJ has new outfit. VE4JC works "F." VE4FW is at Camp Borden. VE4JI, JK, JW, LD, JP, FJ, and DT are active.

Traffic: VE4DQ 114 DT 63 IZ 60 HM 26 BZ 18 GD 6 DX 2.

**BRITISH COLUMBIA**—SCM, J. K. Cavalsky, VE5AL—VE5HA, HS, HU, HV, FY and IG are active in New Westminster. VE5GT is in Vancouver for studies. VE5AM has been sick. VE5EP's 3.5-mc. 'phone was heard in England. VE5DM is working nights. VE5DF handled quake traffic. VE5DV blew new fifty. VE5EZ is after DX. VE5EC volunteered for QSL forwarding job. VE5AG is home after several months with the Cocos Island Treasure Hunting Expedition. VE5HI is on the move.

Traffic: VE5DF 144 EC 31 IE 4 EV 2 AC 75 EE 32 GS 18 HJ 5 DQ 3 GI 32 HH-EP 45 CG 3 GK 5 HQ 104 FE 34 AL 25 FG 16 GK 5 HR 13 HP 353 JC 3.

### PRAIRIE DIVISION

**MANITOBA**—SCM, Reg Strong, VE4GC—VE4MW's traffic total leads. VE4AC has good totals. VE4FT schedules are FB. VE4JB, LC and DI are active. VE4NX schedules VE4BQ. VE4CP has 500 watts input. VE4FN got on the air. VE4WK, AE, RC, IP and EF are on 7 mc. VE4AD is building 'phone. VE4AY is on occasionally. VE4DJ rebuilt receiver. VE4CI worked on DC tests. VE4KU is hunting DX. VE4CS is QRL. VE4RX has plenty of sock. VE4IU is on early mornings. VE4MV is changing to PP. VE4TD is QRL amateur history. VE4DY is building receiver. M.W.E.A. Banquet Contest winners were VE4AG, VE4DU and VE4KX; VE4FU supplied the mermaids.

(Concluded on page 41)



# • I. A. R. U. NEWS •

Devoted to the interests and activities of the  
**INTERNATIONAL AMATEUR RADIO UNION**

President: H. P. MAXIM

Vice-President: C. H. STEWART

Secretary: K. B. WARNER

Headquarters Society: THE AMERICAN RADIO RELAY LEAGUE, West Hartford, Conn.

## MEMBER SOCIETIES

American Radio Relay League  
Associazione Radiotecnica Italiana  
Canadian Section, A. R. E. L.  
Deutscher Amateur Sende-und-Empfangs  
Dienst  
Experimenterende Danske Radioamatører  
Liga Mexicana de Radio Experimentadores  
Nederlandsche Vereeniging voor Internationaal Radioamateurisme

Nederlandsch-Indische Vereeniging voor  
Internationaal Radioamateurisme  
New Zealand Association of Radio Trans-  
mitters  
Norsk Radio Relæ Liga  
Polski Związek Krotkofalowcow  
Radio Society of Great Britain  
Rede dos Emissores Portugueses

Réseau Belge  
Réseau Emetteurs Français  
South African Radio Relay League  
Suomen Radioamatööritti to r.y.  
Sveriges Sandareamatörer  
Unión de Radioemissores Españoles  
Union Schweiz Kurzwellen Amateur  
Wireless Institute of Australia  
Wireless Society of Ireland

## Conducted by Clinton B. DeSoto

### Tests:

A cloud of DX bugs swarmed over the North American continent during the week of March 11th-18th such as has never been known before in the history of man. Every amateur in the United States and Canada, it seemed, could hear just about any country or continent he wanted to. Conditions were wonderful, unbeatable.

There was only one difficulty. Conditions were so good, North American QRM presumably so great, that consistent two-way contacts with these DX stations was virtually impossible for any but the best stations and the best operators. Even so, at this writing, just as the Fifth International Relay Competition closes, rumors are heard of scores topping the ten thousand mark. It has been a marvelous week. It has been an unforgettable occasion.

Latest news of the R. S. G. B.'s national Field Day, rapidly developing into an *international* Field Day, is that the Society is offering a special "Hush Hush" trophy to the British district scoring most points in the event. J. Clarricoats, secretary, suggests that a similar inducement be offered in other countries.

The S. S. A.'s Activity Test last winter, in which some twenty contestants were engaged, was won by Hans Eliaeson, SM6WL, winner also of the Northern Tests in which all stations of the S.S.A., E.D.R., N.R.R.L. and S.R.A.L. took part. The 3.5- and 1.7-mc. bands were used during the Activity Test. The S.S.A.'s yearly speed contest resulted in Folke Berg, SM5UR, being created Swedish Amateur Champion and awarded the Golden Key for the second time. Goran Kruse, SM5TN, a previous title-holder, was runner-up.

### DX:

A few unusual DX reports: Don C. Wallace, W6AM, was reported by William Shurlock,

England, on 7 mc. in early afternoon, English time — daylight all the way.

Vincent L. Rosso, W5KC, was QSO with S. A. R. Malmberg, SM7RV, on 7 mc. at about the same time of day — also daylight all the way, or 18,000 miles the other way round.

Fowler E. Macy, W9MM, has been maintaining a regular skey with Carlos Cordovez, HC1FG, on 4-mc. 'phone.

During the recent B.E.R.U. Contest, writes L. E. Benjamin, W4AJX, the YI gang, went on the air and caused considerable excitement among east coast W stations, with signals that were R6 at times. S. A. Rance, YI2DS, and F. E. Groom, YI6BZ, were heard regularly, and L. A. C. Hamblin, YI6HT, at times.

For the information of DX and traffic men, there are two expedition stations now in the Arctic, working amateurs. SMX is the call assigned to the Swedish Polar Year Expedition situated near Nordenskoldsberget on the Spitzbergen. The station has been worked by Lowell Popp, W9AOE, and we believe works very near the amateur 14-mc. band. NX1XL, the University of Michigan expedition station, is still in Greenland. The location last reported was Peary Lodge, on the northwest coast, several hundred miles north of Upernivik. The frequency is very near 7.3 mc. The new northerly location is making communication with the States difficult, so any work done will be of interest. Report to Fred W. Albertson, W8DOE, Lawyers' Club, Ann Arbor, Michigan.

W1MK, operated by Charles M. Dean, W1AMN, worked XU1U, the Davises, with the Hong Kong station putting in an R7 signal on 14.4 mc., the loudest Asiatic DX yet heard here.

### General:

Formerly bearing the official name "Japana Amatora Radio Liga," at the last meeting of the

organization it was decided to change the name officially into English, and the society is now to be known as the *Japanese Amateur Radio League*, writes K. Kasahara, J1EZ, secretary . . . . The headquarters address of the J.A.R.L. is P.O. Box F77, Tokyo, Japan . . . . Every member of Australia's radio family, the Hutchings, is now actively on the air, we are informed by Eric W. Trebbilcock . . . . Mother, VK3HM, daughter, VK3HQ, and son, VK3HL, all have fine c.c. stations at the home address,



**G5SZ, OWNED BY J. W. RIDDIOUGH, TRANMERE PARK, GUISELEY, YORKSHIRE**

*A 3500-kc. transatlantic station, the qualifying QSO having been with W1ES on last Christmas Eve.*

Callawadda, Victoria . . . . Just a hint: VK3HQ's QSL card bears an excellent portrait of herself . . . . 129 licensed amateur stations in Sweden now, according to an official list dated March 1st . . . . F. H. Harvey, long the only amateur in New Hebrides, reports the initiation of a new ham station there . . . . The name, C. D. Phan, Rannon, Ambrym, N. H.; the call, YH8FN . . . . Harvey's call is YH1RV; the address, "Bonkovia," Epi, N. H. . . . One of the most remote spots on the globe, many New Hebrides natives have never seen a white man; the islands are under the joint control of Great Britain and France, and the administration is known as the Condominium . . . . Other new stations whose calls appear in correspondence . . . . VP4TC, Diogo-Serra, Port-of-Spain, Trinidad, B. W. I. . . . AC2NW, K. H. Cheng, 110 Brue du Baron Cros, French Concession, Tientsin, China . . . . A number of 56-mc. stations around New York City have been QSO an old friend, John F. Grinan, VP5PZ . . . . How? Well, the five-meter transmissions are relayed by C. R. Runyon, Jr.,

W2AG, on the regular 3.5-mc. 9 p.m. sked . . . . The transmissions from the various 56-mc. stations control the transmitter at Yonkers, and the voice comes through perfectly down in Jamaica . . . . Wilmer Allison, W5VV, carries a supply of QSL cards with him on his tennis tours to all parts of the world, or so we are advised by Aussie amateurs he met on his recent visit there . . . . The U. S. A. Davis Cup player had the pleasure of personal QSO's with some of the hams he met over the air, including VK5BY, VK5BO and VK5RD . . . . A special concession was obtained by the R.S.G.B. for participating British stations during the recent B.E.R.U. Contest . . . . All 10-watt stations were permitted to use an input of 25 watts during the event, causing increased interest and the possibility of a much better showing . . . . Unfortunately owing to space reduction, we were last month unable to give the results of the R.C.C.'s recent admirable Accuracy Contest . . . . The winner was Hans Bauer, D4UAN, with 933 points, followed by C. A. Gehrels, PA0QQ, with 428 . . . . Five other stations had scores just under 400; 149 different messages were originated, in 9 different languages, with 1030 QSP's . . . . An excellent outcome, considering that the highest accuracy factor, achieved by E. W. Christensen, LA2W, was 4.937% . . . .

**Special:**

Nearly every I.A.R.U. member-society publishes an official organ. From time to time in these columns we hope to review briefly the nature of these publications. We lead off with the "T & R Bulletin," official organ of the R.S.G.B. Founded in 1925, the "Bull" to-day averages about 40 pages each issue, and is crammed with the essentials of life in British hamdom — including technical and constructional articles as well as Society and personal news. It comes automatically with R.S.G.B. membership, the overseas subscription being 12/6 per annum. This is especially nominal at current rates of exchange, in the United States at this writing amounting to about \$2.40. The address is 53 Victoria St., London S. W. 1.

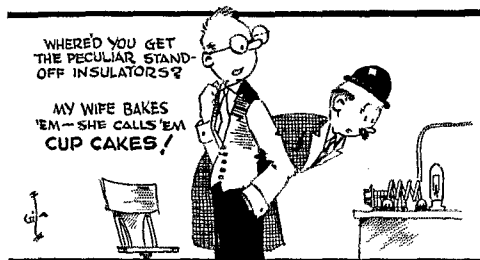



# CALLS HEARD

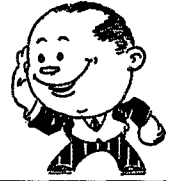

**W4AAQ, N. S. Hurley and S. J. Bayne, R. F. D. 9, Box 124, Birmingham, Ala.**

(3.5-mc. band)

vk4ju k6dsf k6vg

(7-mc. band)

ac1zz eu3eb j1dm j1ee j1eg j1ga kalhr kally kalna kalmr om1tb pk3gw sulcec vs2gy v86ag xpk6er

**VE4AI, H. B. Broten, Meacham, Sask., Canada**

(March 13th)

ear185 ei8bz f8pz on4au on4pz

(March 16th)

d4bit g2ak g2bm g5bvf g5by g5is g5pl ok1ab pasch pasia paszk

**R. E. Knight, 37 Lonsdale Rd., Baines, S. W. 13, London, England**

(14-mc. 'phone band)

w2adi w2et w3cbcf w3is w3zx w8co w8cpf w9bht w9elh

**BRS427, D. A. G. Edwards, 19 Gravelly Hill North, Erdington, Birmingham, England**

(3.5-mc. 'phone band)

ct1ii d4brh d4dld d4uab d4uak d4uaq d4uvo f8et f8gu haf4a ok1kd ok2va on4dj ozik oz1w oz7eh oz7t pasada pasap pasasd pasga pasgh pasmy pasph pasrk pasrp splcc splepl un7ab un7rb uo1em

(3.9-mc. 'phone band)

w1aby w1adm w1bic w2coj w2dlk w2gl w2go w3adl w3aiz w3alz w3blz w8caz w8cq w3hn w3is w3mi w4acz w4bam w4tr

(14-mc. 'phone band)

ok2va sm5rg velak veldm veldq veldw ve2bg ve2ca ve3he w1axa w1bdt w1bnm w1bz w1oaas w1chi w1cpd w1dmo w1lv w1uh w2adi w2afq w2aih w2alk w2aog w2aut w2bwp w2cey w2eda w2dyt w2fl w2gf w2jn w2jp w2tp w2zan w3is w3kd w3mi w3pc w3qv w3zx w6ene w8blg w8aku w8co w8co w8opc w8cpf w8dfl w8faz w8feq w8gly w8wa w9bht w9brx w9elh w9czm w9dhk w9drd w9ewu

**W5CCD, 900 N. 11th St., Waco, Texas**

(March 12th and 13th)

ac2ag vu2lz pk2aa pk4vr pk1hg pk1bo au1kd j1ee j1dm j2za j2cc j2cb j3dq j3cs j3dt j4ch

**R. R. Hay, U.S.S. Memphis, Balboa, C. Z.**

(3.5-mc. 'phone band)

wlcmt w2rs w3cc w4mu w4bfa w5ato

(14-mc. 'phone band)

w1aff w2gx w2zzn w2vpy w5aot w5va w6oqj w8bld w9brx w9bhd

**W1BO, Malcolm Bruce, 9 North St., Plymouth, Mass.**

(7000-ko. band)

(Heard between Jan. 19th and Feb. 9th)

sulec yi2lar yi6bz zs2f

**WINW, 1626 Commonwealth Ave., Boston, Mass.**

(56-mc. 'phones — All w1s)

ci co hy kg kh kj kw rd rh ui vx wd ww axh aom adt aff agk ahb aks ars asf atd bay bex bin btm buv bvl byq byy oaa oac oce ccx cee cff cid cna ejo crw csp ctw evm cwz czn

dek dgd dlq dmq dpa dpp drb dsy dte dzo dxu dzi eow egf ehv elx emd emf emg epx eqt euz ewv eww exi fof feg ffh ffr ffy fga fgs fjq fqv fsk fwg xaj zzaw zzk

## Strays

A room in the machine shop at Purdue University has written on its walls call letters of many hams who have attended Purdue. Many of these calls are fifteen years old, and their owners are still in the "game."

## Getting Quality Performance With Class B Modulation

(Continued from page 17)

transfer the impedance occurring across its secondary to the plate of each tube in exactly the proper ratio. It is absolutely necessary to adjust the plate voltage and plate current of the modulated stage to the correct values to obtain full output from the modulators and to avoid distortion.

The sensitivity of Class B tubes to slight changes in load resistance makes it essential that they be worked into a purely resistive load. This condition is satisfied in plate modulation systems. However, magnetic speakers and small dynamic speakers make a very poor load for a Class B stage because of their high reactance, which permits their impedance to shift drastically with frequency. In this difference in load conditions lies part of the explanation of why Class B is more suitable in the modulator than in the output stage of a receiver.

## FREQUENCY RESPONSE

If all the requirements set out thus far regarding transformers, tubes, loading, etc., have been carefully observed, no difficulty will be encountered in obtaining a very flat frequency characteristic. Low inductance in any of the transformers will, of course, cut the bass response. High leakage reactance will attenuate the highs. If transients are present there may be a broad peak at the upper end of the scale. With reasonable precaution it is possible to keep the characteristic flat within 2 db from 80 to 8000 cycles, and with very high-grade transformers the response will be flat from 30 or 40 cycles up to 12,000 cycles. Large values of output capacity should be used in the plate power supply filter circuits to transmit the very low frequencies, and, of course, the plate supply should have good regulation.



# CORRESPONDENCE

The Publishers of QST assume no responsibility for statements made herein by correspondents

## The Sportsman's Charter

343 Willis Ave., Mineola, L. I., N. Y.

Editor, QST:

Although I have never been to Concord, N. H., it seems to be the birthplace of at least three fine publications: *Foreign Affairs*, *QST* and *The Sportsman*. In the February, 1933, issue of the latter there appears "The Sportsman's Charter," which I believe is well worth reprinting in *QST*.

— *Newbold Wheelock, W2OQ*

### THE SPORTSMAN'S CHARTER

"This magazine is dedicated to these convictions:

"That sport is something done for the fun of doing it and that it ceases to be sport when it becomes a business, something done for what there is in it;

"That amateurism is something of the heart and spirit — not a matter of exact technical qualifications;

"That the good manners of sport are fundamentally important;

"That the code must be strictly upheld;

"That the whole structure of sport is not only preserved from the absurdity of undue importance, but is justified by a kind of romance which animates it, and by the positive virtues of courage, patience, good temper, and unselfishness which are demanded by the code;

"That the exploitation of sport for profit kills the spirit and retains only the husk and semblance of the thing;

"That the qualities of frankness, courage, and sincerity which mark the good sportsman in private life shall mark all discussions of his interests in this publication."

*Reprinted by permission of "The Sportsman"*

## How Many Times?

Long Beach, Cal.

Editor, QST:

Every issue of dear ole Quist up to and including the last number has contained some discussion regarding the correct number, the geometrical progression of, or if you are a student of Herr Einstein, the phase relation thereof and pertaining to the method of obtaining communication with another station by means of sending a long or short series of CQ's.

We have heard propounded numerous times the deep logic of sending that magic number three (3) for at least three times. But I am coming out with a startling new idea to be known hereafter as the "Annonian Hypothesis" which I wish to offer to hamdom at this time.

First, each and every station shall determine, by the simple process which I shall presently outline for you, which Order or Magnitude he or she is in. By multiplying the number of the Order or Magnitude by the magic number three (3) he or she immediately obtains the number of times to CQ to obtain the greatest efficiency, i.e., W6ANN is in the Third Order — a station of the Third Magnitude — three times three is nine, Sooooooooo, W6ANN sends CQ nine times nine. (You needn't snicker, you wouldn't hear me if I CQ'ed all night.) W6AM, a station of the First Magnitude, sends the usual three times three, because three times one is still three.

Now as to the process of determining which Magnitude or Order your station is in, I offer the following: From a map determine a station two thousand miles from your location. Get in communication with this station. (Stations unable to work two thousand miles are automatically relegated to the Nth order. N times N approaches one over infinity so sed stations should either keep a CQ machine on continuously or try five meters.)

Now that the station at two thousand miles distance is in communication ask the operator what type of receiver is in use. For standardization we have in all experiments used a three tube blooper and same must be used in determining Magnitudes. Ask the operator what Order you are in and use this number in all further CQ's.

Magnitudes are determined by the following method. Tune the receiver to 7 mc. at 7 o'clock your time. Hear the loud station covering five points? He is in the first layer and of the First Order or Magnitude. As soon as he quits you will discover three stations in the space he has just vacated. These are second layer stations and of the Second Magnitude. When these three stations quit you will hear (if the first station hasn't come back) nine other stations covering the space previously occupied. These are stations of the third layer and of the Third Magnitude. It is not likely that you will hear the 27 stations under these nine, but if you are so fortunate or have a "single sniggle" these stations are the fourth layer or Fourth Magnitude.

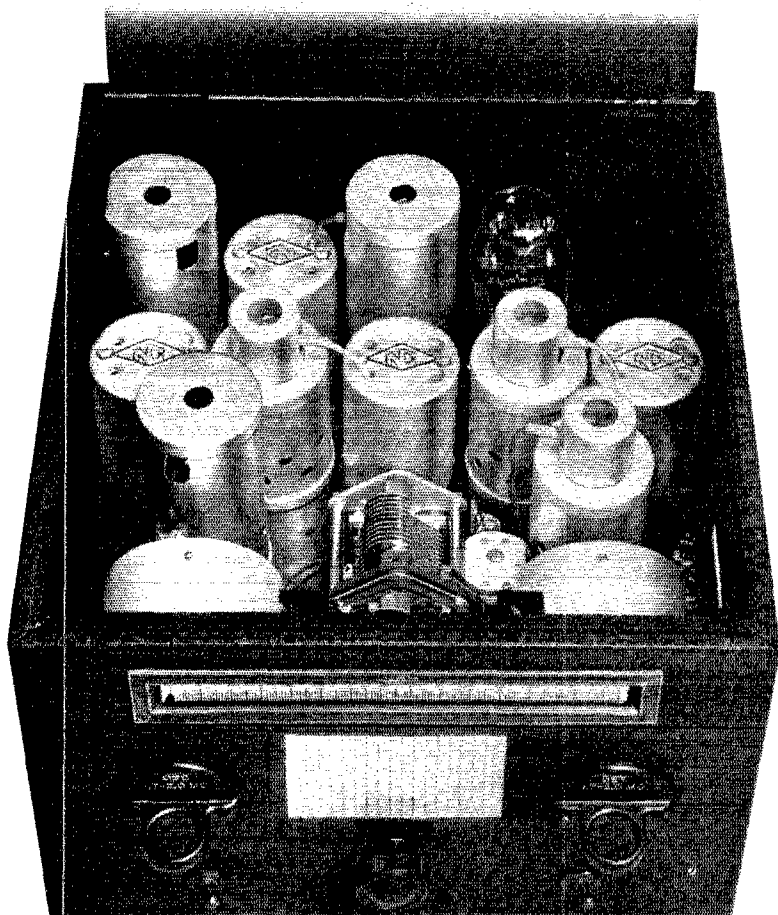

## THE NATIONAL FB-7

Good design in a high frequency receiver should imply much more than exceptional selectivity and sensitivity. These characteristics, alone, are not enough to insure good performance — it is necessary that circuit noises arising from “shot effect” in the tubes, and thermal agitation in their associated circuits be correspondingly small, for it is by this means only that the highest signal to noise ratio is obtained.

The FB-7 has a signal to noise ratio even better than the quietest battery operated regenerative receiver, and this is made possible through careful correlation of tubes, coupling circuits, filtering and circuit arrangement.

**NATIONAL COMPANY, INC., MALDEN, MASS.**

# Over 600 questions and answers covering all radio operator license examinations

— including 1933 official questions with answers.

This new edition of Nilson and Hornung's well-known book will help you pass examinations and to know your stuff better in any field of practical radio. Brought completely up-to-date. Enlarged to cover more amateur work; also police, aeronautical and other radio.

**Just Published**  
Nilson and Hornung's

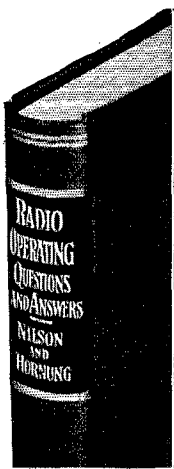

## RADIO OPERATING QUESTIONS AND ANSWERS

389 pages, 5½ x 8, 96 illustrations, \$2.50

New 5th Edition

including

- information on broadcasting, marine, aeronautical, police and amateur operating
- many new questions and answers on latest types of transmitters and other equipment
- more information on amateur operation, including unlimited amateur telephone operator's license
- new radio laws
- new questions and answers on important technical, general and theoretical topics
- regulations governing issuance of all classes of radio operator's license examinations

Every question is typical of those you meet on examinations; answers are complete, illustrated, and give the information essential to meet every situation. For amateurs, short wave fans, men who are preparing for operator examinations or technical positions. Radio companies give preference to licensed operators for all positions. This book gives quick, direct preparation for all examinations. Examine it free.

See this book 10 days free  
Send this coupon

McGRAW HILL BOOK CO.  
330 West 42nd Street, New York City

Send me Nilson and Hornung's Radio Operating Questions and Answers, new 5th edition, postpaid, for 10 days' free examination. I will send \$2.50 or return the book postpaid within 10 days of receipt.

Name.....

Address.....

City and State.....

Position.....

Name of Company..... QST-5-33  
(Books sent on approval in U. S. and Canada only)

Now having found your order from the above it is no difficulty to know just how many times to call CQ, and if you hear someone CQ'ing indefinitely you know he is in the Nth minus One order.

The following chart should be clipped and hung in the shack giving you instantaneously the Magnitude of the incoming CQ. Likewise how many times you should rechart your station at least twice a day.

### ANNONIAN HYPOTHESIS

- First Magnitude — W6AM, W9UZ — 1 kw. input
- Second Magnitude — Overloaded 852's (see W6CUH)
- Third Magnitude — You & Me with 10 & 203-A
- Fourth Magnitude — Those TNT 45's
- Nth - 1 Magnitude — Lids with any tube
- Nth Magnitude — You when my locals come on
- Nth + 1 Magnitude — Lines of Yellow Spectrum  
— W. Annie Adams, Jr., W6ANN

### One Point Seven Five

5822 East Green Lake Way, Seattle, Wash.

Editor, *QST*:

In spite of all that has been said in *QST* about the advantages of 1.75-mc. operation, there is still a scarcity of signals on that band, at least on the west coast, and I would like to encourage more operators to try it. I had not operated consistently on 1.75 mc. until recently and I now find that the only thing wrong with it is the lack of stations, especially on c.w. I have worked VEAMZ, W6FFP, and W6AME, each about 800 miles distant, with an input of only 15 watts to a 46 in the final amplifier. My antenna system is far from elaborate. Any 80-meter antenna can be made to work on 1.75 mc. More operators should try this band at the same time. While operators try to fight QRM on 3.5 mc., 1.75 mc. remains free from any signals. Let's try to distribute the signals a little more proportionately between the two bands.

I find no trouble keeping a schedule with W7IG on that band and know I could keep others if there were stations to keep them with. Schedules with stations several hundred miles distant could be maintained since I have heard 9th district stations QSA5 here every night. Remember that in the U. S. more than one-half the band is reserved for c.w. alone. Here's hoping that more operators will find time to try a little 1.75-mc. operation.

— Niilo Koski, W7LD

### Punching Glass

Millis, Mass.

Editor, *QST*:

On page 51, February *QST*, much laughter has been made over the Danvers lad's remark as to starting a hole in a window pane with a hammer and a prick punch. I would like to refer you to

Allen D. Cardwell Mfg. Corp.  
81 Prospect Street,  
Brooklyn, New York.

Gentlemen:

I am contemplating building another Amateur Transmitter in the very near future. Of course I want CARDWELLS, and would appreciate a catalog describing all types, from you.

In this "neck o' the woods" we don't say Condensers, we say CARDWELLS.

I've used them for years and in my opinion they are the ACME OF PERFECTION.

Would also appreciate any late dope on Amateur Transmitters and Receivers.

Yours very truly,

In this  
**NECK O' THE WOODS**  
we don't say **CONDENSERS**

we say -

**CARDWELLS**



"In this 'neck o' the woods' we don't say condensers, we say CARDWELLS!"

Pages of print could not better express the sincere convictions of hosts of Amateurs and others, in countless cities and "necks of the woods" from coast to coast and throughout the world.

Significant too, and none the less convincing because lacking as a motive the pure pride and desire of possession of the Amateur for the best to be had, are the constant and consistent purchases of CARDWELL condensers by the largest manufacturers of really fine equipment, and the great communication companies. Make no mistake, they *know* condensers.

If you, too, will say CARDWELL, you can't go wrong.

The famous CARDWELL Midway "Featherweight" is made in 15 standard single models, also in split stator and double combinations and to order. There is nothing fragile or delicate about the Midway. It is the strongest, most rugged and serviceable of small condensers—a man's condenser that asks no odds and will hold its own anywhere.

CARDWELL condensers, variable and fixed, are made in many sizes and capacities for high, medium and low powered transmitters and for receivers.

Send for literature.

## THE ALLEN D. CARDWELL MFG. CORP.

83 PROSPECT STREET, BROOKLYN, NEW YORK

Any reliable supplier should cooperate with you to enable you to get what you want. He can get CARDWELLS for you if he does not keep them in stock. Get what you want—insist on CARDWELLS. Order direct from us if your dealer will not supply or let us tell you where you may buy.

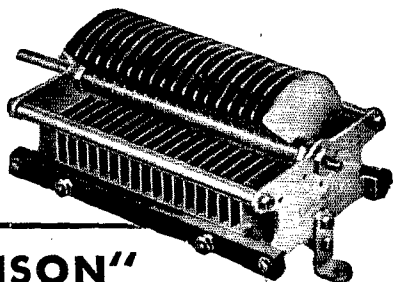

**"THE STANDARD OF COMPARISON"**

# LOST

and seldom found:

**REPUTATIONS  
COLLAR BUTTONS  
SCISSORS, ETC., ETC.**

and to this abbreviated list may we add almost any back issue of *QST*. Nearly every day we have to offer regrets for our inability to furnish certain back issues of *QST*. Now for many years *QST* has carried a cut similar to the one just below.



**WHY ?**

In order that devotees to the art may keep their *QSTs*—protect them against loss or damage. They are offered to readers of *QST* at a modest cost. Each binder accommodates twelve issues of *QST* and the index. The binders are sturdy, cloth covered, deep maroon in color, excellent in appearance and cleverly designed to take each issue as it is received and hold it firmly without mutilation. Don't delay. Order today a binder for your 1933 copies — and enough binders to accommodate the file of *QSTs* which you have already accumulated.

**\$1.50 EACH**

POSTPAID ANYWHERE

**THE AMERICAN RADIO  
RELAY LEAGUE, INC.  
WEST HARTFORD ■ CONNECTICUT**

July, 1925, *QST*, in which there is an article by a Mr. Twitchell, who at the time was an expert in the art of drilling glass panels. The very first operation in drilling a hole in glass is to mark the spot with a prick punch and hammer, the object being to break the glaze. Of course the procedure is not so strenuous as that when marking steel or some other metal, but the point remains that it is done.

I would also like to speak for the success I have had in drilling glass by Mr. Twitchell's method. I have drilled many glass bowls and drinking glasses for use as lead-in insulators, etc., and have never once broke one in the process of drilling. I also would like to say if Mr. Twitchell's method is followed to the letter the same thickness of glass can be drilled much more quickly than the same thickness of steel!

This may seem like a lot of words over nothing, but it may help to show that prick-punching glass is not so funny as it sounds.

— James Wood, W1AYG

## The Note with the Smile

2800 Bailey Ave., New York City

Editor, *QST*:

How many times have you sat back in your chair after a very fine QSO with some ham you've never met personally and exclaimed, "Gosh, but he surely is a swell guy. I wish I could meet him sometime." Was it the words he spelled out to you that brought you such satisfaction? No, I'm sure it wasn't — it was simply because his *note* had a very pleasing personality. His was the "note with the smile." It isn't wholly the quality of the signals nor the fist, but there is something else quite intangible and inexplicable that makes all the difference in the world between the note that smiles and the one that frowns.

There are many kinds of notes, just as there are many kinds of personalities. Some signals are crisp and business-like. Why can most hams distinguish the commercial station immediately on hearing the note? It isn't the speed, for some send quite slowly, nor is it the quality, but just that there is that unmistakable crispness about it. Then there are those lazy, drawing notes, the ones with the negative personality that don't seem to care where they go or what answers they will bring. It seems that all those sloppy r.a.c. and n.d.c. notes are in that class. And then there are those gruff, selfish notes. The broad raw a.c. and r.a.c. ones that don't give a hang for the other fellow . . . And next come those familiar, faltering, timid little chirps from the beginners. Those notes always seemed to say to me, "Please, won't someone answer and don't judge too harshly — I'm doing the best I can —." And finally we come to the note that we all should strive to have — the note that bubbles over with enthusiasm and good cheer. The note that says, "It's great to be alive and to be able to participate in the greatest of all hobbies — amateur radio." The clean healthy note — the note with the smile.



# The HAM SUPER

## MAKES ZEDDERS AND AUSSIES R7-R8 IN EARLY EVENING

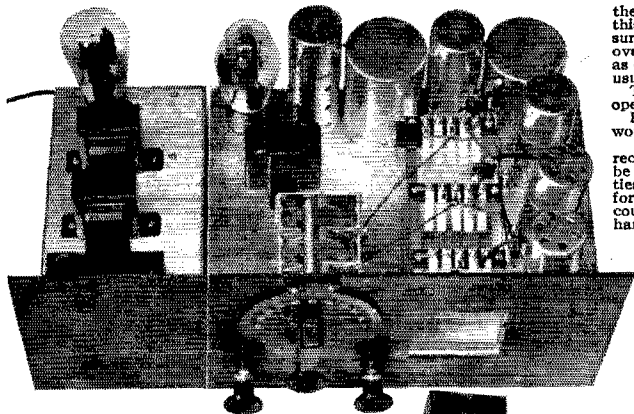

Already the new Ham Super is making records for other ham receivers to shoot at — and it was introduced only last month. Read a bit of what 9CYE, George Miller of Chicago says of it after two weeks' operation:

"The new Ham Super is undoubtedly the best receiver for sensitivity, selectivity and single signal tuning that I ever heard of used. Its performance is remarkable on all Amateur frequencies, band-spread or coverage, CW or fone, and it is a real pleasure to carry on communication with such reliability, without the usual QRM and heavy background interference so common to most receivers today.

The sensitivity is so high that I bring in New Zealand and Australian stations much earlier in the evening and with more signal strength. Some of

their R7-8 signals could easily be mistaken for stations on this continent before they give their call letters. Another surprise was to hear west coast stations fairly consistently over a period of two weeks up until 10:30 A.M. (C.S.T.) and as early as 3 P.M. (C.S.T.) on 7 megacycles — rather unusual reception for this frequency band.

That novel idea of changing frequencies is such an easy operation and works great.

I am thoroughly satisfied. I does all that you said it would."

If you want a really advanced, up-to-the-minute Ham receiver, find out about the Ham Super. Good? — it's got to be good to do that, and it was designed by amateur authorities for whom you have the greatest respect. Send in a stamp for complete details of the Ham Super, the new electron coupled frequency meter-monitor (all A.C.) and other hot ham transmitting and receiving specialties.

### LAST MINUTE SPECIAL

A new and compact all A.C. electron coupled frequency meter and monitor combined. It covers all Ham bands and is only 6" square. And the price? — depression low.

## MCMURDO SILVER, INC.

1136 W. Austin Ave. Chicago, Ill.

MCMURDO SILVER INC.  
1136 W. Austin Ave., Chicago, U.S.A.

Enclosed find 3c stamp for which send me details of the Ham Super and all amateur apparatus.

Name .....

Address .....

Town ..... State .....

CRYSTALS! Everybody and his neighbor are grinding them! But it has taken five years of experience grinding broadcast and commercial crystals to produce and sell Hipower Crystals at these Low Prices. For the S.S. receiver Hipower set-tested filter crystals complete with air-gap, plug-in holder and mounting. Hipower crystals close to your specified freq. exact calib. 1700-3500-Kc. bands 1" sq. \$1.35, round \$1.60; 7000-Kc. \$4.25, 1" blanks 65c, tested finished blanks 95c, dust-proof plug-in holders with mounting \$1.00. Grinding compound, course, medium, fine 65c, each grade 25c. No waiting. HIPOWER CRYSTAL CO., 3607 N. Luna Ave., CHICAGO, ILL.

... Classes now forming for  
**AMERICA'S FIRST**

**RESIDENCE SCHOOL**

in

**Practical Radio Engineering**

With our first announcement last month, we received hundreds of replies from ambitious radiomen about this new RESIDENCE course. We stress the necessity to inquire about enrollment NOW, because every class will be limited.

**NEW CATALOGUE — JUST OUT!**

This beautiful and interesting new 36-page booklet which gives complete information about the Residence and Extension courses, FREE to all who write:

**CAPITOL RADIO ENGINEERING INSTITUTE**  
14th and Park Rd. N. W. (Dept. QST-5) Wash., D. C.

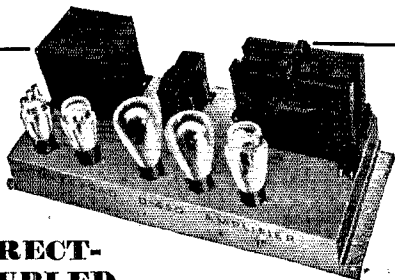

**DIRECT-  
COUPLED**

**AMPLIFIERS** For Every Purpose

**E**LECTRAD has greatly refined and improved the basic direct-coupled amplifier circuit. Always the simplest, the most compact, and the most economical — ELECTRAD has given it super-efficiency and marvelous tone.

Five models, using the newest type tubes and ranging from 1.6 watts to 21.9 watts of undistorted power output, are now available for every normal need. List prices, \$32.50 to \$195.00, less tubes.

Write Dept. Q-5 for  
Complete, New Catalog

175 Varick St. New York, N.Y.  
**ELECTRAD**

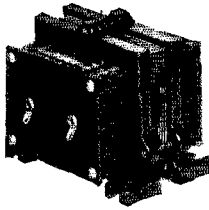

## KENYON TRANSMITTING MATERIAL

is quality merchandise conservatively rated. The construction is of a uniform, symmetrical nature.

This material may be purchased at the following wholesale prices only from authorized Kenyon distributors

Net Wholesale Price

### PLATE TRANSFORMERS

|   |        |
|---|--------|
| KPTA — 750-0-750 V. 165 MA D.C. 2-7½ V. — 3 A. windings, 1-2½ V. — 10 A. winding..... | \$8.40 |
| KPTE — 1400-0-1400 V. 400 MA D.C.....   | 18.00  |
| KPTD — 2000-0-2000, 3000-0-3000, 350 MA D.C.....                                      | 38.40  |

### FILTER CHOKES

|   |        |
|---|--------|
| KFRD — 8 Hy. 300 MA D.C.....            | \$6.00 |
| KFRF — 25 Hy. 300 MA D.C.....           | 13.50  |
| KSRH — 12-30 Hy. "Swinging" 400 MA..... | 9.00   |

### MODULATION CHOKES

|                           |         |
|---------------------------|---------|
| KMRD — 30 Hy. 400 MA..... | \$24.00 |
| KMRC — 50 Hy. 350 MA..... | 30.00   |

### FILAMENT TRANSFORMERS

|  |        |
|--|--------|
| KF-366 — 2½ V.C.T. 10 A. 10,000 V..... | \$3.60 |
| KF-204 — 11 V.C.T. 8 A. 5000 V.....    | 6.00   |

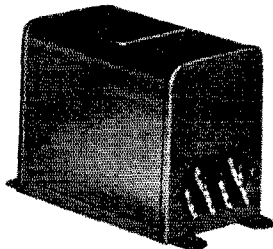

## KENYON

All Purpose Class B Amplifier Components represent the finest material obtainable in medium priced amplification equipment. Refinements in design and highly supervised production has made possible units which are unapproachable for overall quality in material of this price range.

### CLASS B UNITS

Net Wholesale Price

|  |        |
|--|--------|
| B-591 — Driver 59 plate to 59 grids.....                                   | \$3.60 |
| BMT — P.P. 45 plates to 2-210 grids.....                                   | 3.60   |
| BCI — P.P. 250 plates to 2-203A grids.....                                 | 4.50   |
| B-59 RF — P.P. 59 plates to R.F. stage.....                                | 3.90   |
| BMO — P.P. 210 plates to R.F. stage.....                                   | 4.50   |
| B-59 PT — 570-0-570 — 165 MA, 2½ V.C.T. 3A. — 5 V. 3A., 2½ V.C.T. 10A..... | 7.20   |
| BC-110 — Swinging filter choke — 10 Hy. 200 MA D.C.....                    | 2.40   |

#### NEWLY RELEASED FOR 2A3 TUBES

|  |      |
|--|------|
| B-2A30 — P.P. 2A3 plates to 4000, 2000, 500, 15, 8, and 4 ohms.....                    | 3.90 |
| B-2A3 PT — 400-0-400 — 125 MA, 2½ V.C.T. — 10 A., 6.3 V.C.T. — 2.5 A., 5 V. — 5 A..... | 4.80 |

ASK YOUR KENYON distributor for Bulletin ABTRM which lists more than 250 standard units for radio, broadcast and amateur transmission applications, 16 schematic layouts for Class A and Class B amplifier systems also shown.

**KENYON TRANSFORMER CO., INC.**  
122 Cypress Avenue New York, N. Y.

Not so long ago I was having a splendid rag-chew with W2CFS of New York City, when it occurred to me to put the theory to a test. I was sure that my sigs could not only have personality but they could also tell the listener something about myself — even down to personal appearances. Sounds a little far fetched, doesn't it? But listen to what happened. I asked him if my note gave him any indication as to my personal appearance and I asked him to describe just what impression he received. Without the slightest trace of hesitancy, his sigs came flashing back with a description of me that was really astounding. He guessed my age within a year and how my signals could possibly have told him that I have blue eyes and blonde hair, is a bit beyond me. Perhaps it was just an excellent guess on his part — but then when I described him with almost equal accuracy, I became firmly convinced that dots and dashes are not merely electrical impulses, but that they are living things that carry the mark and personality of their owner with them wherever they go. I have tried the same experiment many times since then and the results are almost unbelievable.

Put your personality into your signals. When you sit down to transmit — remember that your attitude counts more than the watts in your antenna, remember that the other fellow is looking for someone pleasant to talk and work with. Make your note tell the listening world that you are a cheerful and smiling fellow. Keep your dots and dashes tingling with clean, healthy enthusiasm. It's the "Note with the smile" that counts.

— Joseph L. Reiffin, W2CWP

## Pure D.C.

Washington, D. C.

Editor, *QST*:

The regulations require that "amateur stations must use adequately filtered direct current power supply or arrangements that produce equivalent effects to minimize frequency modulation and prevent the emission of broad signals, except that the use of unrectified alternating current power supply will be considered satisfactory in the amplifier stages of an oscillator-amplifier transmitter."

This regulation was modified by the exception so that many of our fellow hams would be spared the expense of expensive rectifier and filter equipment. Since that regulation was written the cost of rectifier equipment for the voltages we require has been lowered and excellent filter equipment can be obtained for a fraction of the cost of several years ago.

In view of this lowered cost of obtaining a high-grade power supply, we have come to the time when we amateurs should voluntarily offer to discard our "obsolete" transmitters and adopt modern ones. Due to our increase in numbers, it becomes imperative that we do so. Congestion on all workable bands is becoming so bad that there

*"The Martians may have been signalling us for centuries hoping that some day we would detect these signals and answer them."*

HIRAM PERCY MAXIM

## "Life's Place in the Cosmos"

AN ABSORBING BOOK BY  
HIRAM PERCY MAXIM

President of the A. R. R. L.

MR. MAXIM'S new book deals brilliantly but in an easy, conversational manner with astronomy, physics, biology, psychology. It discusses the possibility of radio as a means of interstellar communication; the development of life on the earth and its probabilities in other worlds; the structure of our own solar system, our galaxy, other galaxies, the whole stupendous stellar universe. Few of us can read this fascinating book without gaining from it a much better understanding of the complex universe of which we are such a small part. Perhaps the most remarkable fact about the book is its "understandability" — the fact that without sacrificing either dignity or authority, Mr. Maxim has brought the whole subject within the easy comprehension of any average person with scientific or technical inclinations. The book is lavishly illustrated, including some of the finest astronomical photographs ever made. No radio amateur should fail to read "Life's Place in the Cosmos." Mr. Maxim has looked at it all through the eyes of a radio amateur. In consequence his book will be of particular interest to those whose point of view is the same as his own.

Price, \$2.50, postpaid

EDWIN VALENTINE MITCHELL, INC.

99 Lewis Street

Hartford, Conn.



LOWELL'S GLOBE OF MARS

• Dark areas believed to be vegetation. The lines are the "canals" believed by some to be the work of intelligent beings.

EDWIN VALENTINE MITCHELL, Inc.

Enclosed find \$2.50. Send me postpaid a copy of Hiram Percy Maxim's new book "Life's Place in the Cosmos."

Name.....

Address.....

### PANELS—BAKELITE—RUBBER—ALUMINUM All Sizes Cut to Order BAKELITE TUBING & RODS

Drilling, Engraving & Special Work  
ALUMINUM CANS—6 x 5 x 9, \$1.70—6 x 10 x 7, \$2.75—7 x 9 x 14, \$4.45, and many other sizes. Special sizes to order.  
ALUMINUM CHASSIS—Threaded brass studs for 6/32 screws. Lengths from 1/2" to 6"—price 5c to 30c.  
Insulating bushings for all size shafts from 75c to \$1.90 per dozen  
Couplings in brass or bakelite — 15c



Mail orders filled same day. Transmitting frames and racks  
UNITED RADIO MFG. CO., Est. 1923, 191 Greenwich St., New York

### FUSSY HANDBOOKS for FASTIDIOUS PEOPLE

The regular 10th Edition of the Radio Amateur's Handbook in cloth binding with gold lettering. \$2.00 postpaid anywhere.

AMERICAN RADIO RELAY LEAGUE  
West Hartford, Connecticut



## EXTRA!!!

Premier Prices Now within  
the Reach of All

80 and 160 meter, X or Y cut crystal within 20 kc. of specified frequency. Calibrated in plug-in type holder — COMPLETE WITH HOLDER \$5.00

Crystal — Mounted in plug-in type, air-gap holder for Single-Signal receiver — 465 kc. to 525 kc. — COMPLETE WITH HOLDER.... \$7.50

All calibrations made with a General Radio Frequency Standard — Checked with Bureau of Standards Transmissions and Naval Observatory time signals. All calibrations guaranteed accurate to within .001%

Crystals of all descriptions made to order—Prices upon request

**PREMIER CRYSTAL LABORATORIES, INC.**

53 PARK ROW

NEW YORK CITY

## ANNOUNCEMENT

• Eveready Raytheon 4-Pillar Tubes are now being sold and distributed by their manufacturer — The Raytheon Production Corporation — and they will be known henceforth as Raytheon 4-Pillar Tubes.

• The Raytheon Production Corporation is carrying forward the same extensive research and engineering that was responsible for the famous BH tube which ushered in AC sets and the patented 4-Pillar Principle used in Eveready Raytheon Tubes which have "set the pace" for performance and long life.

• The present outstanding advertising program will be maintained and technical service to radio set manufacturers and amateurs will be continued and expanded.

Write Department 20 for a copy  
of our new output tube chart

## RAYTHEON PRODUCTION CORPORATION

30 E. 42 St. .... New York, N. Y.  
55 Chapel St. .... Boston, Mass.  
445 Lake Shore Drive ..... Chicago, Ill.  
555 Howard St. .... San Francisco, Calif.



## RADIO FREQUENCY CHOKES

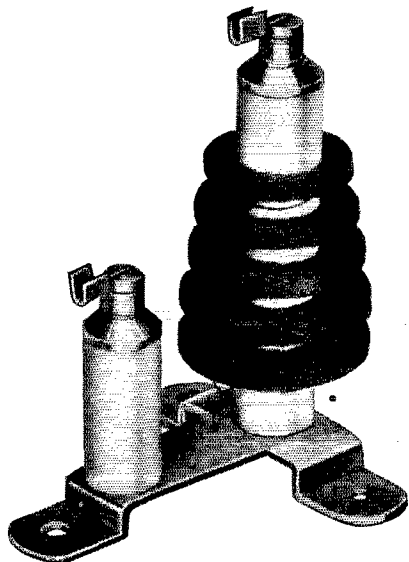

**TYPE R-152**

An Isolantite-mounted choke for medium- and high-power transmitters, with a continuous universal winding divided in five tapered sections. Metal base for mounting, insulated for 10,000 volts.

|                                  |              |
|----------------------------------|--------------|
| Inductance.....                  | 4 m.h.       |
| Distributed Capacity.....        | 1 mmf.       |
| D.C. Resistance.....             | 10 ohms      |
| Continuous Current Rating.....   | .6 amps.     |
| Intermittent Current Rating..... | .8 amps.     |
| <b>List Price.....</b>           | <b>\$.25</b> |

(Less usual Trade Discount)

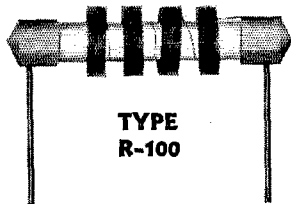

**TYPE R-100**

An Isolantite-mounted choke for H.F. receivers and low-power transmitters, with a continuous winding divided in four universal-wound sections. For pigtail connection or standard resistor mountings.

|                           |              |
|---------------------------|--------------|
| Inductance.....           | 2½ m.h.      |
| Distributed Capacity..... | 1 mmf.       |
| D.C. Resistance.....      | 50 ohms      |
| Current Rating.....       | 125 mils.    |
| <b>List Price.....</b>    | <b>\$.75</b> |

(Less usual Trade Discount)

## NATIONAL COMPANY INC.

61 Sherman Street

Malden, Mass.



is no satisfaction in working at times, and the maintenance of important traffic schedules is becoming more difficult.

We naturally have in our ranks proponents of the r.a.c. transmitter. They say it gets through. There is little doubt that this is true but that is also the best argument against their use. In getting through they drown out many signals of greater merit and perhaps more importance than the signal causing the jam. R.a.c. gets through — but at what a terrible expense.

Improved receivers undoubtedly help matters, but receivers that permit operating through QRM from r.a.c. notes cost much more than the proper filter equipment at the transmitter would cost. It is the old game of "passing the buck" from the owner of the transmitter to the owners of many receivers. This is distinctly unfair and does not meet with the basic principles of American political policy — namely "the greatest good for the greatest number."

Many samples of notes could be described and cases of interference experienced from them recited, but that is unnecessary. We have all waited many minutes to hear the station we had been working while a broad r.a.c. signal finished a long CQ. "Were you mad?" If so, why not do something about it? If the consensus of opinion is for the abandonment of the unfiltered power supply, then we can have the exception stricken from the regulations.

— Roy C. Corderman, W3ZD

## Right

Eugene, Oregon

Editor, QST:

From the result of experiments here at W7QW it seems that the customary system of coupling the antenna to the plate tank of a push-pull amplifier with a split antenna coil, or a two-wire feed line in the case of voltage fed Hertz antennas, is a lot of unnecessary work. A single antenna coil coupled to one end of the tank or a single feed line the proper distance from the center on either end loads both tubes equally just as if a double pick-up were used.

I have checked this with separate plate meters in each tube and with a transmitter that heated the tubes and in every case the loading was the same no matter to which end of the tank the antenna was coupled. The input-to-output ratio was the same as if two coils were used.

In two cases where I had the opportunity I asked others to back off one coil of their push-pull stages and couple the other up until the input was the same and both times the signals had the same volume. Omission of the second coupling coil will save a lot of work as well as being a boon where space is limited in a transmitter. This makes it possible to convert a single-ended final stage to push pull with almost no additional equipment than another tube.

— Thomas C. Hall, W7QW

# — get that NATIONAL "FB-7" || from CHI-RAD!

This new receiver that is proving a real sensation with Hams who know their stuff is available at CHI-RAD at lowest prices. Complete Specifications for this capable performer with its high inherent stability, I. F. gain, special shielding and proper chassis completely described in March QST, now offered by CHI-RAD at \$26.46 net. Coils, per pair, \$5.88 net. Small Power Pack No. 5887 AB, \$14.40 net. Large Power Pack for use with 59 tube, \$20.30 net. Also everything needed for Short Wave work — including many items available nowhere else. Single-Signal Type FBX, \$11.76 additional.

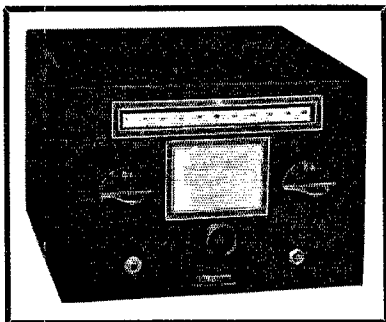

— where there's the Biggest Line at Best Prices

## SEND FOR BOOK

The CHI-RAD Catalog — new 1933 edition — deserves a place on every Ham's operating table. It lists everything you need to get the most out of your hobby — at the lowest possible cost for high grade equipment. Send for your copy TODAY, enclosing 10c to help cover cost of preparation and mailing.

## NATIONAL AIR-TUNED TRANSFORMER

The famous NATIONAL Air Dielectric Tuned I. F. Transformers — with their many outstanding features including Self Locking Rotors, Isolantite Insulation, Adjustable Coupling, Micrometer Tuning — Velvet Vernier Type, All Peaking Adjustments at Top of Shield, etc., are waiting for you at CHI-RAD at rock-bottom price. If you are working with Single-Signal reception you must have them — and this new, completely redesigned National gives results you want. Get the CHI-RAD Catalog NOW for prices and complete specifications.



## CHICAGO RADIO APPARATUS CO., INC.

415 S. Dearborn St.

Dept. Q2

Chicago, Ill.

**ALUMINUM BOX SHIELDS** Genuine stock, silverdip finish, 5 x 9 x 6, \$1.65. 10 1/2 x 6 x 7, \$2.65. Any Size to Order. SOMETHING NEW! Your call letters, or any marking for your panel, on BLACK aluminum ribbon. Looks like engraving on bakelite. 5c. each, sample, 8c.

We Specialize in Radio Parts Exclusively Exact Size →

**W2FZ**

1/2 watt Neon Lamp — 35c

**BLAN, the Radio Man, Inc.** 177 Greenwich St. New York City

## LOW RANGE FUSES

- Littelfuses for Instruments: Amps.: 1/100, 1/32, 1/16—20c ea. 1/8, 1/4, 3/8, 1/2—15c ea. 1, 2—10c ea. For milliammeters, ham rectifiers, etc. Use 1/3 for radio B circuits. High Voltage
- Littelfuses: 1000, 5000, 10,000 volt ranges in 1/16, 1/8, 1/4, 3/8, 1/2, 3/4, 1, 1 1/2, 2 amps. Renewable. Price 35c to \$1.25 ea. NOW—\$100 PROTECTION GUARANTY. Get New Cat. #5.
- LITTELFUSE LABS. 1784 Wilson Ave., Chicago

"Quicker than a Short circuit!" **LITTELFUSES**

## AMATEURS West of Rocky Mountains

We can supply all parts for the new circuits

Send for your Catalog of Nationally Advertised Transmitting and Receiving Parts at **LOWEST PRICES**

Amateurs' Headquarters of the West

### RADIO SUPPLY CO.

H. A. Demarest, President  
912-914 So. Broadway Los Angeles, California  
(W6FB1 located in Building)

## QST

## OSCILLATING CRYSTALS

"Superior by Comparison"

### WHY YOU SHOULD USE SCIENTIFIC RADIO SERVICE CRYSTALS

- 1 Since 1925, we have been specializing in producing Piezo Electric Crystals exclusively.
- 2 Since 1925, Scientific Radio Service Crystals have stood the test and are recognized the world over for their Dependability, Output and Accuracy of Frequency.
- 3 Since 1925, owners of Broadcast and Commercial Short Wave stations have found that no chances can be taken in getting the cheaper grade of crystals and that invariably they call on Scientific Radio Service for the Best.
- 4 Since 1925, we could be depended upon to make Prompt Shipments. This coupled with a crystal Second to None considering Output and Accuracy of Frequency has earned during these years a reputation which we jealously guard. Therefore, Get the Best.

Price list sent upon request

## SCIENTIFIC RADIO SERVICE

"The Crystal Specialists"

124 JACKSON AVENUE, UNIVERSITY PARK  
HYATTSVILLE, MARYLAND

# To Our Readers who are not A.R.R.L. members

**Y**OU should become a member of the League! That you are interested in amateur radio is shown by your reading of *QST*. From it you have gained a knowledge of the nature of the League and what it does, and you have read its purposes as set forth on the page opposite the editorial page of this issue. We should like to have you become a full-fledged member and add your strength to ours in the things we are undertaking for Amateur Radio. You will have *QST* delivered at your door each month. A convenient application form is printed below — clip it out and mail it today.

*A bona fide interest in amateur radio is the only essential qualification for membership*

AMERICAN RADIO RELAY LEAGUE  
West Hartford, Conn., U. S. A.

I hereby apply for membership in the American Radio Relay League, and enclose \$2.50 (\$3.00 outside of the United States and its Possessions, and Canada) in payment of one year's dues, \$1.25 of which is for a subscription to *QST* for the same period. Please begin my subscription with the ..... issue. Mail my Certificate of Membership and send *QST* to the following name and address.

.....

.....

.....

Do you know a friend who is also interested in Amateur Radio, whose name you might give us so we may send him a sample copy of *QST*?

.....

Thanks

## Graduating to O.-A. Transmitters on 56-Mc.

(Continued from page 28)

preceding stage should be at least two inches. Closer coupling will not give greater output but will only cause trouble. Look to the neutralization or to the output of the stage ahead if the final amplifier output is low.

In neutralizing the final amplifier, the use of a thermogalvanometer is to be preferred. A neon bulb will give a rough indication, however. If available, a small milliammeter can be connected in series with the grid return of the final amplifier. When the amplifier is truly neutralized, no change in the rectified grid current should occur when the amplifier plate tank is swung through resonance. Of course the plate voltage should be removed from the amplifier when neutralizing it.

Plate current values run practically the same as at the lower frequencies when the respective types of transmitters outlined are operating properly, and 46's or 210's have been excited to an input of 50 watts as Class C amplifiers without difficulty. Antenna coupling and modulation problems are the same as those encountered with the self-excited type of 56-mc. transmitter now found in many amateur shacks. The modulator that is satisfactory with the present self-excited oscillator will work even better with separately-excited Class C amplifier using the same type tubes. Needless to say, the overall performance of the modernized transmitter will be well worth the effort.

## Still More Tubes

(Continued from page 30)

portion. No. 4 grid is the detector control grid, while No. 5 (connected inside the tube to No. 3), screens the No. 4 grid from the plate and other tube elements. The connection to the No. 4 grid is brought out to a cap on top of the tube.

The 2A7 and 6A7 have small 7-prong bases and the small dome-top bulb. So far it has been impossible to obtain sockets to fit the new base (the 7-prong socket for the 59 is built on a larger radius) so that no practical information as to the adaptability of this tube to high-frequency use has been obtained. Besides the oscillator-first detector application, it could also be used as a second detector and beat oscillator for c.w., and may be useful in beat-frequency oscillators.

The pin connections, using the notation on page 30, March *QST*, follow: Pin 1, Nos. 3 and 5 grids; Pin 2, plate; Pins 3 and 4, heater; Pin 5, cathode; Pin 6, No. 1 grid, Pin 7, No. 2 grid; Cap, No. 4 grid.

Normal plate voltage for both the oscillator and detector portions is 250 volts; the screen (grids 3 and 5) takes 100 volts. The bias on grid No. 4 is 3 volts for maximum gain; volume may be controlled by varying the bias on this grid.

## THE 2B7 AND 6B7

These two belong to the duo-diode group; they differ from the 55 and 85 in having pentodes in-

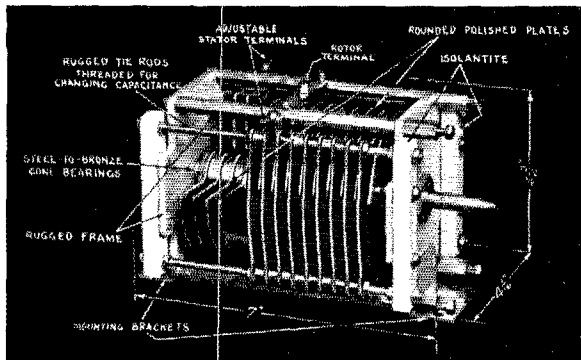

GENERAL RADIO COMPANY  
*announces a NEW*  
**HIGH VOLTAGE**  
**Variable Condenser**

For Amateur and Experimental Work

Flexible design to allow all of the following uses —

1. Double section type — capacitances per section readily adjustable from 25 to 305 micromicrofarads — useful in experimental set-ups for both low and high "C" circuits.
2. Double section — equal capacitances — for push-pull circuits requiring balanced capacitances.
3. Sections connected in parallel to furnish maximum capacitance of 330 micromicrofarads.
4. Condenser can be readily modified into single section model, with 330 micromicrofarads maximum capacitance.

A low-loss condenser of precision construction having these specifications:

- Capacitance per section — adjustable by the user from 25 to 305 micromicrofarads.
- Voltage breakdown — conservatively rated at 3,500 d.c. — air gap of 0.098".

Insulation — Isolantite in weak field.

Plates — aluminum, 1/16" thick — all edges rounded and polished to reduce corona losses.

Bearings — long, conical self aligning — bronze to steel.

Shaft — 3/16" steel.

Terminals — rotor terminal bridged for even current distribution — stator terminals adjustable in position for different circuits.

Frame — 3/16" aluminum end plates — heavy hexagonal tie rods.

Spacers — adequate brass, machined rotor and stator spacers assuring minimum contact resistance.

Mounting — four point panel, self supporting — two brackets supplied for breadboard mounting.

Type 639-A High-Voltage Variable Air Condenser, \$15.00  
 Sent postpaid to any place in United States or Canada upon receipt of cash with order.

Order direct from this advertisement from

**GENERAL RADIO COMPANY**    30 State Street    **CAMBRIDGE, MASS.**

or from our San Francisco branch at 274 Brannan Street

**NEW 1933 CORNELL CATALOG**



A complete line of oil and electrolytic transmitting condensers described in our new 1933 Catalog. Sent free on request. Write for your copy now.

**CORNELL ELECTRIC MFG. CO., Inc.**  
 Long Island City    New York

Learn at Home to be a

**Good  
 Radio  
 Operator**

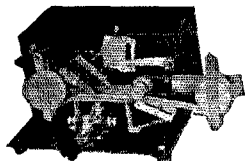

*It's Easy*

with  
 The NEW MASTER

**TELEPLEX**

Code Teaching Machine

Pleasant, interesting work. An officer aboard ship. Opportunity to see the world and get paid for it. No experience necessary. We furnish a Complete Code Course and lend you The NEW MASTER TELEPLEX. Course prepared by leading authorities on the subject, makes learning easy as A B C. . . . TELEPLEX has instructed more students in code in the past ten years, than all other systems combined. . . . It is the only instrument ever produced that will record your own sending in visible dots and dashes, and then repeat it to you audibly on headphones. . . . Enables you to make your own records, as many as you want without extra cost. . . . Provides unlimited practice material. Used by U. S. Army and Navy, R. C. A., A. T. & T. Co. and principal schools. Get started on the code NOW! If you can already read the code we pick you up at your present speed. *Easy terms.* Write for folder Q-17 giving full details.

**TELEPLEX COMPANY**

76 Cortlandt Street

New York, N. Y.

**HAVE YOU ALL  
 DELTA BULLETINS?**

Bulletin AD—Transformers and Chokes

Bulletin AD-1—20 and 200 watt Class B Amplifiers

Bulletin AD-2—Complete Power Supply Chassis and Parts for Chassis

If Not

Send for Your Copies

F. S. Dellenbaugh, Jr.

Pres. & Chief Engr.



G. E. M. Bertram

Treas. & Gen. Mgr.

SUCCESSORS TO ACME APPARATUS CO.

---

---

## QUESTIONS—

What is the regulation concerning amateur station logs? What persons may operate amateur stations? How does a vacuum-tube oscillator operate? What class of message holds precedence over all others? What is the regulation governing the location of amateur stations?

## ANSWERS—

the right answers — to these and more than sixty other questions which you may be asked when taking your operator's license exam, are given in full in the latest reprint of "Passing the Government Examination for Amateur Operator's License." Originally a series of two articles appearing in the January and February, 1930 issues of *QST*, they proved so popular that the entire back copy supply of these issues was exhausted within a year. Rewritten, they were again published in October and November, 1931 and reprinted several successive times, with necessary revisions. Every amateur preparing to take the exam NEEDS the "Passing" articles, for in their convenient economical pamphlet form can be found the answer to every exam question. 20c per copy, postpaid. No stamps, please.

**THE AMERICAN RADIO RELAY LEAGUE  
WEST HARTFORD, CONNECTICUT, U.S.A.**

---

---

stead of triodes in the output portion. Considerably greater voltage amplification is therefore obtainable from these tubes, making them have greater overall sensitivity than the duplex-diode triodes. Since the tubes are chiefly of interest to builders of broadcast receivers, we shall not go into details about them beyond mentioning that they can be used to give detection, audio amplification and automatic volume control in much the same way as the older duo-diode types. If desired, the pentode portion also can be used as an r.f. amplifier.

Characteristics of the 2B7 and 6B7 are identical except for heater ratings which correspond to those of the 2A7 and 6A7 respectively. Both tubes have the small dome-top bulb, small 7-pin bases, and grid caps. Pin connections are: Pin 1, screen; Pin 2, plate; Pins 3 and 4, heater; Pin 5, cathode; Pins 6 and 7, diode plates; Cap, control grid.

### THE 2A6

The 2A6 is a duo-diode high-mu triode with a 2.5-volt, 0.8-amp. heater. Its characteristics are the same as those of the 75, described in April *QST*, and it simply furnishes a tube of the 75 type in the 2.5-volt series.

The information on the above types was received from RCA-Cunningham and Eveready-Raytheon.

— G. G.

---

### W8AFM

(Continued from page 33)

power supplies for the crystal oscillator and doubler are below the level of the desk.

The large number of crystals permits operation in almost any part of all three bands. During operation the frequency can be changed 10 kc. or so simply by selecting another crystal. No change in tuning is required, so it is unnecessary for the operator to move from the desk.

The receiver is a Hammarlund Comet Pro. It will later be mounted in a rack which will occupy the left-hand side of the desk and will contain in addition an electron-coupled frequency meter and monitor.

---

### Checking the Performance of First Detector

(Continued from page 35)

have been made which are not universally true. To begin with, the addition of two sine waves to give a heterodyne voltage does not give a curve mathematically identical with a modulated sine wave. This has been shown by Terman,<sup>2</sup> and others. However, if one voltage is very small compared to the other, as in this case, the results are identical for all practical purposes. Secondly, the effect of the load resistance on the plate current changes has been neglected. With screen-grid tubes, the internal plate resistance is several megohms so that the usual plate load of one or

<sup>2</sup> "Radio Engineering," Chap. VIII.



# HERE IS NEWS!!

## How Would You Like to Win One of These Prizes?

### FIRST PRIZE:

A real ultra-modern commercial type amateur transmitter — built by Radio Engineering Laboratories — capable of 175 to 200 watts output in the antenna! An xmitter that emits a pure DC crystal control type of note and may be operated on 20, 40, 80 or 160 meters! Constructed on the new rack type style, standing 6 feet high!

### SECOND PRIZE:

A NATIONAL "AGS" Communication type receiver.

### THIRD PRIZE:

A Hammarlund "COMET PRO."

AND FORTY-EIGHT  
OTHER PRIZES!

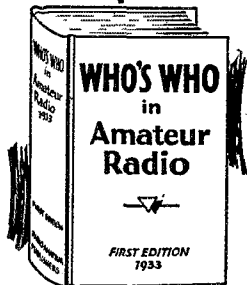

Every licensed amateur has an equal opportunity to win. The conditions of the contest are simple.

These sensationally generous prizes are our contribution to Amateur Radio, — and to the thousands of operators cooperating with us in the publication of the first edition of "Who's Who in Amateur Radio."

### SEND IN FOR FULL PARTICULARS

We will forward you, absolutely without obligation, a circular carrying the picture of the prize transmitter, and the other awards.

Remember, your chance to win is as good as the next man's!

## RADIO AMATEUR PUBLISHERS

1107 BROADWAY      NEW YORK CITY

### Introductory 2-BUTTON MICROPHONE

*Special*  
A good, 200 ohms per button microphone at a low price. Pure gold contacts. Low hiss level. Duraluminum diaphragm. Scientifically damped. Frequency, 40 to 3500 cycles. Dia. 2 3/4", over all thickness 1", chromium finish, weighs 1 lb. packed. For any type mounting — desk, suspension ring, banquet SPECIAL stand, sound truck, etc. A \$10.00 value for \$3.95. Send for catalog on other microphones and amplifiers. EACH

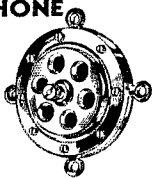

SOUND ENGINEERING CORP.  
418 N. Leavitt St. Chicago

### — Good News for Hams — New Low Price, National SW 3, Famous A.C. or D.C. Ham Receiver

\$14.12

Brand new  
in original  
factory cartons.  
Coils  
extra.

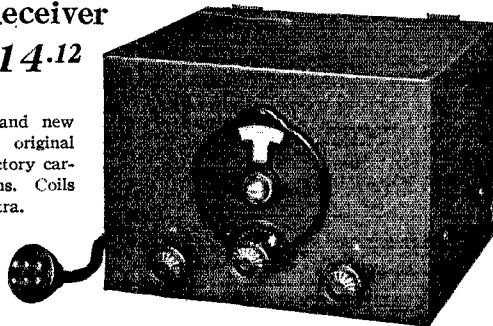

M. & H. were the first to supply complete Single Signal Super Kits. Our prices are low—our quality the highest. We solicit your inquiries on these instruments.

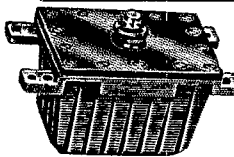

We Still Have a Few Navy-Type  
Dubilier Condensers \$3  
.004 Mfd.—12500 volts.  
Mica dielectric—In aluminum cases. Tested and guaranteed.

## M. & H. SPORTING GOODS CO.

512 MARKET ST., PHILADELPHIA

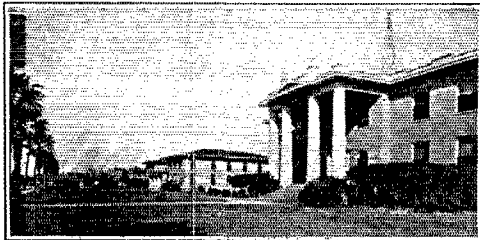

In 3 to 7 months we train you to secure government license. Course consists of Wireless Code, Radiophone, Microphone-Studio Technique, Television, Service, Police, and Aeronautical Radio. We are authorized to teach RCA Institutes, Inc., texts. Return coupon for details.

Name .....  
Street or Box.....  
City and State.....

## PORT ARTHUR COLLEGE

PORT ARTHUR, TEXAS

# MORE METERS

See Page 72 of April QST  
for Mfrs names — ALL NEW

Millimeters — All standard ranges —  
3 1/2" Dia. Projection Mount \$2.00  
3 1/2" Dia. Flush Mount 2.25

Microammeters — Laboratory Type  
Square Case 0-1000 Micro-Amp. \$4.25  
0-500 " " 5.00

Voltmeters — Double Range D.C. 0-50-500  
with external multiplier \$3.50

Write for list of other meters at special prices  
10% Deposit on C.O.D. orders

## HAVE YOU A HAMMARLUND PRO?

Write for free instruction sheet on changing to  
the new Air-Tuned intermediates.

## KALTMAN & ROMANDER

62 Court St. Newark, N. J.

Successors to Kaltman & Kennyhertz

# TO

save yourself 50c a year (newsstand  
copies cost \$3)

get your copy of QST first

be sure of getting your copy (newsstands  
often sold out)

be eligible for appointment or election  
to A.R.R.L. offices

be eligible to sign petitions for your  
Director, your representative on the  
A.R.R.L. Board

be eligible to vote for Director and  
Section Comm. Manager (only A.R.R.L.  
members receive ballots)

lend the strength of your support to the  
organization which represents YOU at  
Madrid, at Washington — at all im-  
portant radio conferences

have YOUR part in the A.R.R.L.,  
which has at heart the welfare of all  
amateurs

Use the application blank on page 68 of  
this issue.

two-hundred thousand ohms is negligible by com-  
parison. For tubes in which this condition does  
not hold, more exact results may be obtained in  
the following manner:

It is necessary to make readings for a series of  
different plate voltages. The plate current is then  
plotted against the applied alternating voltages.  
Load lines from any convenient plate voltage are  
then drawn in as in Fig. 4. From the intersections  
of these lines with the plate current curves, one  
may obtain the so-called rectified voltages, which  
may then be plotted against the a.c. or oscillator  
voltages. The slope of the latter curves gives  
directly the gain of the detector circuit. This  
process is essentially that described by Nelson<sup>3</sup>  
for ordinary detector tubes.

## Standard Frequency Transmissions

| Date    | Schedule | Station | Date     | Schedule | Station |
|---------|----------|---------|----------|----------|---------|
| May 8,  | A        | W1XP    | June 2,  | B        | W9XAN   |
| May 5,  | B        | W9XAN   |          | B        | W6XX    |
|         | B        | W6XX    | June 7,  | BB       | W1XP    |
| May 10, | BB       | W1XP    |          | C        | W9XAN   |
|         | C        | W9XAN   | June 9,  | B        | W9XAN   |
| May 12, | B        | W9XAN   |          | A        | W6XX    |
|         | A        | W6XX    | June 14, | B        | W1XP    |
| May 17, | B        | W1XP    |          | BB       | W9XAN   |
|         | BB       | W9XAN   | June 16, | BB       | W6XX    |
| May 19, | BB       | W6XX    |          | A        | W9XAN   |
|         | A        | W9XAN   | June 17, | BX       | W6XX    |
| May 20, | BX       | W6XX    | June 18, | C        | W6XX    |
| May 21, | C        | W6XX    | June 23, | A        | W6XX    |
| May 26, | A        | W6XX    | June 25, | C        | W1XP    |
| May 28, | C        | W1XP    | June 28, | A        | W1XP    |
| May 31, | A        | W1XP    | June 30, | B        | W9XAN   |
|         |          |         |          | B        | W6XX    |

### STANDARD FREQUENCY SCHEDULES

| Time<br>(p.m.) | Evening<br>Sched. and<br>Freq. (kc.) |      | Time<br>(p.m.) | Afternoon<br>Sched. and<br>Freq. (kc.) |        |
|----------------|--------------------------------------|------|----------------|--|--------|
|                | A                                    | B    |                | BB                                     | C      |
| 8:00           | 3500                                 | 7000 | 4:00           | 7000                                   | 14,000 |
| 8:08           | 3600                                 | 7100 | 4:08           | 7100                                   | 14,100 |
| 8:16           | 3700                                 | 7200 | 4:16           | 7200                                   | 14,200 |
| 8:24           | 3800                                 | 7300 | 4:24           | 7300                                   | 14,300 |
| 8:32           | 3900                                 |      | 4:32           |  | 14,400 |
| 8:40           | 4000                                 |      |                |  |        |

| Time<br>(a.m.) | Sched. &<br>Freq. (kc.)<br>BX |      |
|----------------|-------------------------------|------|
|                |                               |      |
| 6:00           |                               | 7000 |
| 6:08           |                               | 7100 |
| 6:16           |                               | 7200 |
| 6:24           |                               | 7300 |

The time specified in the schedules is local standard time  
at the transmitting station. W1XP uses Eastern Standard  
Time, W9XAN, Central Standard Time, and W6XX,  
Pacific Standard Time.

### TRANSMITTING PROCEDURE

The time allotted to each transmission is 8 minutes,  
divided as follows:

2 minutes — QST QST QST de (station call letters).

3 minutes — Characteristic letter of station followed by  
call letters and statement of frequency. The characteristic  
letter of W1XP is "G"; that of W9XAN is "O"; and that  
of W6XX is "M."

1 minute — Statement of frequency in kilocycles and  
announcement of next frequency.

2 minutes — Time allowed to change to next frequency.

<sup>3</sup>J. R. Nelson, "Detection With The Four-Electrode  
Tube," *Proc. I. R. E.*, June, 1928.

# IT'S EASY to UNDERSTAND!

The League has recognized the problem of the beginner who has had absolutely no past experience in radio, and yet wants to get into it as quickly, easily and inexpensively as possible — and it has solved the problem for you through the publication of its beginner's booklet, "How to Become a Radio Amateur." Its 32 pages make learning the code easy, enable the rawest beginner to pass the license examination, tell how to build a simple station, with clear illustrations and easily followed building instructions . . . and it's yours for only 25c, postpaid. No stamps, please.

*American Radio Relay League*  
WEST HARTFORD, CONNECTICUT, U. S. A.

## Radio Operating Radio Servicing—

Prepare for the new Government Radio Operating license examinations; Radio Operator, Marine and Broadcasting. Also Radio Amateur Telegraph and Telephone. Resident courses. Write for booklet "Opportunities in Radio."



West Side YMCA Trade & Technical Schools  
4 West 63rd Street, New York City

## Special Emblems for Handy's Henchmen

All the King's horses and all the King's men couldn't have more attractive colors than those available only for

*Section Communications Managers*  
*Route Managers*  
*Official Relay Station Appointees*

OFFICIAL A.R.R.L. EMBLEM in  
Special red color for the S. C. M.  
Special green color for the Route Manager  
Special blue color for the Official Relay  
Station appointee



*Note:* Red and green colors in pin type only. Blue emblem available both in pin and lapel button types.

$\frac{3}{8}$ " size \$1.00 each

AMERICAN RADIO RELAY LEAGUE  
West Hartford, Connecticut



## UNIVERSAL 3-Piece Adjustable Combination Stand

This full utility, all-purpose, adjustable banquet and floor stand outsells any stand on the market — Three telescoping sections — Collapsible for easy transportation. Can be extended to full standing height — Honest, solid construction — Snappily finished in highly polished nickel plate — Lowest price in history. Only \$10.00 list, including 8 suspension springs.

UNIVERSAL MICROPHONE CO., Ltd.  
424 Warren Lane Inglewood, Cal., U. S. A.

# FREE Candler System Code Guild Sked

## DAILY C. S. PRACTICE PROGRAMS ON AMATEUR BANDS

Send for your FREE copy of the Candler Short Wave Press Schedules now. Learn to copy px from Candler trained ops, sending out of many of the principal px stations. Amazing results in short time. FREE ADVICE IF "STUCK." Write Candler. No obligation. Junior Course for beginners. Advanced Course for ops with speed of 10 wpm or over who want to get in 30 to 45 wpm class and copy behind. Also Radio Typing Course. Save time and money by sending for FREE BOOK today.

Get the benefit of Candler's twenty years' experience in developing experts. Let him show you how he can do for you what he has done for so many others. Your questions will be answered personally and promptly. No obligation. Write now!

**If you want to be a FAST and ACCURATE OPERATOR get your training where the CHAMPIONS GOT THEIRS**

"Candler training enabled me to copy 56½ wpm for the all-time record." — T. R. McELROY, Official Champion Radio Operator of the World, 46 Everdean St., Boston, Mass.

**WALTER H. CANDLER**  
World's Only Code Specialist, Instructs You Personally



**Candler System Co., Dept. 53**  
6343 South Kedzie Ave. Chicago, Illinois

### THE TRANSMITTING STATIONS

W1XP: Massachusetts Institute of Technology, Round Hill Research, South Dartmouth, Mass., Henry G. Houghton in charge.

W9XAN: Elgin Observatory, Elgin National Watch Company, Elgin, Ill., Frank D. Urie in charge.

W6XK: Don Lee Broadcasting System, Los Angeles, Calif., Harold Peery in charge.

### WWV 5000-KC. TRANSMISSION

The 5000-kc. transmissions of the Bureau of Standards station, WWV, are given every Tuesday continuously from 12:00 noon to 2:00 p.m., and from 10:00 p.m. to midnight, E.S.T. The accuracy of these transmissions is to better than 1 cycle (one in five million).

—J. J. L.

## New Books

**Life's Place in the Cosmos**, by Hiram Percy Maxim. Published by D. Appleton & Company, New York City. 177 pages. Price, \$2.50.\*

Comparable to the famous and fascinating books of Eddington and of Jeans, Mr. Maxim's new book will be especially interesting to radio amateurs. Perhaps insufficiently technical for some of our deeper students, it is nevertheless thoroughly readable and informative. It provides food for intriguing conjecture on the subject of interstellar communication — a field so far quite as virgin as the field in which Marco Polo operated 600 years ago. It leads us to the thrilling thought that, from our meagre beginnings, some future generation of amateurs may figure their DX in "megamiles."

\* Obtainable from QST Book Department.

## WESTON METER BARGAINS



Model 301

GENUINE



Model 267

Universal A.C. — D.C. With 5-Position Scale. \$8.40  
Complete Set Resistors and Shunts. . . . . 7.95  
0-1 Milliammeters (1000 Ohms per Volt) . . . . . 5.25  
0-10 Milliammeters. . . . . 5.25  
0-100 Milliammeters. . . . . 5.25  
0-10, 25, 50 or 100 D.C. Voltmeters. . . . . 4.45  
0-150 Voltmeters D.C. . . . . 5.88  
0-15 A.C. Rect. Type. . . . . 6.00  
0-150 A.C. Rect. Type. . . . . 6.50  
Postage included in above prices

Milliammeters, 0-1, 0-10, 0-25, 0-50, 0-100, 0-300, 0-500 . . . . . \$5.00  
Ammeters 0-2, 0-3, 0-7½, 0-10, 0-15. . . . . 5.00  
Voltmeters D.C. 0-15, 0-20, 0-25, 0-50, 0-100, 0-200. \$6.50; 0-500, \$7.40; 0-1000. . . . . 8.50  
A.C. Voltmeters, Rect. Type 0-15 or 0-150. . . . . 6.00  
Milliammeters 0-1 (1000 Ohms per Volt) . . . . . 6.00  
25% deposit with C.O.D. orders

UNIVERSAL WIRELESS SALES CO.

416 N. Leavitt St. Chicago, Illinois

## PANELS DRILLED AND ENGRAVED

### EXPERIMENTERS

Synthane Corp. will cut, drill and engrave panels to your specifications.

Send us your layout for estimate.

### SHORT WAVE COIL FORMS

Outside diameters—1"—1¼"—1½".

Any wall thickness. Threaded if desired.

SYNTHANE CORP., OAKS, PA.

## Help Us—and Help Yourself!

THE Post Office Department recently announced that a fee of 2 cents, payable by the publisher, shall apply to each change of address notice we receive from any post office. During the course of a year we receive hundreds of such notices. It is our desire to minimize the expense of this service, which heretofore has been free. You can help by promptly advising us direct of your new address, giving your old address at the same time.

Many publishers, as you probably know, have a very strict change-of-address policy, requiring as much as five or six weeks' advance notice if they are to be held responsible for delivery of the current issue of their publications. Recognizing QST's intense reader interest, we have never established such a policy, believing each reader should receive every copy of QST even though in many cases the fault of non-delivery is not ours. We plan to hold to this policy, but your cooperation, particularly in view of the direct expense now involved, will be appreciated.

Won't you help, both in the matter of lessening the number of 2-cent fees and in our desire to promptly supply each issue of QST as it appears?

# HAM-ADS

(1) Advertising shall pertain to radio and shall be of nature of interest to radio amateurs or experimenters in their pursuit of the art.

(2) No display of any character will be accepted, nor can any special typographical arrangement, such as all or part capital letters be used which would tend to make one advertisement stand out from the others.

(3) The Ham-Ad rate is 15¢ per word, except as noted in paragraph (6) below.

(4) Remittance in full must accompany copy. No cash or contract discount or agency commission will be allowed.

(5) Closing date for Ham-Ads is the 25th of the second month preceding publication date.

(6) A special rate of 7¢ per word will apply to advertising which, in our judgment, is obviously non-commercial in nature and is placed and signed by a member of the American Radio Relay League. Thus, advertising of bona fide surplus equipment owned, used and for sale by an individual or apparatus offered for exchange or advertising inquiring for special equipment, if by a member of the American Radio Relay League takes the 7¢ rate. An attempt to deal in apparatus in quantity for profit, even if by an individual, is commercial and takes the 15¢ rate. Provisions of paragraph (1), (2), (4) and (5) apply to all advertising in this column regardless of which rate may apply.

Having made no investigation of the advertisers in the classified columns, the publishers of *QST* are unable to vouch for their integrity or for the grade or character of the products advertised.

OVER six pounds radio data, circuits, bulletins, 50¢ postpaid. Beyond Rockies, 75¢. Kladag, Kent, Ohio.

US Navy ball bearing dynamotors. Ideal high voltage supply operating from storage batteries. General Electric 24/1500 volt 350 watt \$37.50; 24/750 volt 150 watt \$25. On 12 volts output 375. Westinghouse 27½/350 80 mills \$10. Mounted twins \$15; 500 cycle 500 watts (generator) \$7.50. List. Henry Kienzle, 501 East 84th Street, New York.

MICROPHONE and meter repairs. Low prices. Quick Service. Sound Engineering Corp., 416 N. Leavitt St., Chicago.

QUARTZ — Direct Importers from Brazil of best quality pure Quartz suitable for making piezoelectric Crystals. Diamond Drill Carbon Co., 719 World Building, New York.

SENSATIONAL microphone value — Universal Model "Y" — Experimenters' single-button, watch model type. 200 ohms. Pure gold spot center diaphragm. Only \$2.00, including valuable 1933 general catalog with diagrams. Universal Microphone Co., Ltd., Inglewood, California.

TRANSFORMERS, reactors made to order. Accurate, dependable. Prompt shipments. Write for quotations. Baker Engineering Laboratories, Fort Wayne, Indiana.

VOLOVOX Dynamic Microphone. A new standard of microphone value. \$7.75 postpaid in U. S. Baker Engineering Laboratories, Fort Wayne, Indiana.

WANT transmitting condensers from Canuck Hams. Duty too high from U. S. unless real bargain. VE3GG, Hydro, Ontario. 500 watt CC rig complete, for sale. Similar to W9UZ, one unit, frame and panel, 9 Jewells 3 Westons, 4 stages, commercial appearance. Must sacrifice to continue school. \$225. plus freight charges. Norman Hower, 46th Squadron, Randolph Field, Texas.

TRANSMITTERS — push-pull 210s with 600 volt power supply. Completely self-contained rack and panel job, \$22. Ernest Ruland, Natick, Mass.

FOR sale — Esco MG 110V a.c., 500v 200 mil. Has filter and field rheostat, \$25. E. Gosselin, Box 367, Hyannis, Mass.

WANTED: 32 or 6 volt dynamotor. W9GEE, Iona, S. Dak. WANTED: R. F. thermo-galvanometer, O-115 MA. J. H. Rohweder, Tecumseh, Mich.

QSLs, 75¢ a 100. Two colors. W9DGH, 1816 5th Ave., N., Minneapolis, Minn.

QSLs. World's finest! No trash! Service — honesty — quality guaranteed! Samples on request. W8DED, Holland, Mich.

QSL cards, message blanks, stationery, snappy service. Write for free samples today. W1BEE, 16 Stockbridge Ave., Lowell, Mass.

WILL trade transmitter, receiver and parts for outboard motor. Selph, 304 Albemarle Ave., Richmond, Va.

WANTED: 100 to 250 watt, panel mounted, c.w. and phone transmitter; must be bargain. Earl Conklin, 1605 Worthington St., Pittsburgh, Pa.

WANTED: a 203A or 852 or 860. W9FRH, 1005 S. 17th St., Fort Dodge, Iowa.

QSLs, 100 one color 50¢; two colors 80¢. Samples, 2143 Indiana Ave., Columbus, Ohio.

TRADE B flat tenor saxophone. Wanted: tubes, meters. VEG3C, 354 Princess Ave., London, Ont.

FOR sale — Teleplex and Crosley three tube converter. W4MA.

FINEST QSLs. Samples. Cuts for printers. T. Vachovetz, Elmsford, N. Y.

WE212Ds, two used 600 hours, \$18. each — one used 1000 hrs. \$10. RCA 845 ten hours, \$10. National SW3AC receiver with tubes and five sets of coils, includes 20, 40, 80 band-spread \$16. W3BIH, 6318 N. Park Ave., Phila.

ATTRACTIVE new QSLs. Free samples. Huntington Press, 190 Huntington Ave., Buffalo, N. Y.

QSLs by W2AEY. Guaranteed printing. 338 Elmora, Elizabeth, N. J.

QUARTZ crystals. Your frequency \$1. with holder. Guaranteed. W9ER, Timken, Kans.

BUY, sell, trade anything. W9ER, Timken, Kan.

QSLs — SWLs. W6DOU, Hayward, Calif.

SELL — RCA course, Teleplex, tapes, \$16. Hartley transmitter, \$3. W1CCA.

QSLs by Maleco. Finest in the country. Free samples. Maleco, 1512 Eastern Parkway, Brooklyn, N. Y.

SELL RCA course, 25 lessons. W2CQG.

PHONE transmitters — 100% class B modulated 40 watt carrier. Crystal controlled rack and panel unit with meter and power supplies. Completely self-contained, \$65. Ernest Ruland, Natick, Mass.

OMNIGRAPHs, Teleplexes, Vibroplexes, meters, receivers, etc. Bought, sold, traded. Ryan Radio Co., Hannibal, Mo.

247 TNT transmitter, 500 volt pdc power supply, tubes, key filter, etc., \$20. Arso calibrated monitor, 20, 40, 80 meter coils, \$5. Harold Finley, Bosworth, Mo.

WANT pair 03As or 04As, transmitting condensers, variable and filter, no off brands. W5CRQ.

TELEPLEX \$10. W9LNU, 2123 W. 111th St., Chicago.

SELL — WE 560 and RCA 100 dynamic speakers; also brand new transmitting and receiving equipment. Schedler, 719 Hoyer St., North Bergen, N. J.

ESCO item twelve motor generator for sale, double commutator, four bearing, 1000v 200w, \$40. Thompson, 1301 Findlay Ave., New York City.

VIBROPLEXES, new \$12. Rebuilds, \$6.50 to \$10. Guaranteed. Frank Lydeard, 28 Circuit, Roxbury, Mass.

CRYSTALS: x cut, 1" or 1 1/16" sq., accurately and neatly finished, \$2. Oscillating blanks with comp. \$1. Will c.o.d. W8DLM, Rochester, Mich.

CRYSTALS: Guaranteed excellent oscillators, 160 or 80 meters, \$1.35 postpaid. 1" Blanks 65¢. Irregular shapes 25¢. Standard dust-proof plug-in Holders 75¢. Pure Brazilian Quartz \$1.50 lb. and up. Fisher Laboratory, 1200 E. Nevada, El Paso, Texas.

QSL cards. Neat, attractive, reasonably priced. Samples free. Miller, Printer, Narberth, Pa.

SELLING out — write for list. W2MT.

WESTERN Electric 4-D radio receiver with loop and battery box. Make offer. Sam Waite, Box 37, Northbridge, Mass.

SALE — Esco motor generator 110 a.c. to 750v 400 mills. d.c. Good condition, \$30. W9CSM, Whitewater, Wis.

TRADE or sell extra crystals. Best offers take. Write W9GKH, Milledgeville, Ill.

WANTED — Morecroft's "Principals." W8HYH, East Liverpool, Ohio.

QSLs, samples, W1BPF, 245A Boston Ave., Medford, Mass.

FREE Plug-in, dustproof holder with G.R. plugs with each crystal purchased. Crystals: X cut, 1" square ground to maximum output. More power, better frequency control with our crystals. 1750 and 3500 kc. bands ground to within 0.1% of your specified frequency — \$4.50 each. 7000 kc. band within 15 kc. of your frequency — \$5.50. Calibration .05%. Crystals, ovens and oscillators for commercial use cheerfully quoted on. Precision Piezo Service, 427 Asia St., Baton Rouge, La.

CRYSTALS: The "Big Boys" use Smith Precision. KAINA, ZL2BQ, VE5AL, K6BAZ, W6CNE, W6FT, W6EM, W6HT, W6KA, W6OJ, W6PH, K7UT, etc. Hundreds sold at \$7.50. Same quality now \$2.01. See April Ham-ad. W6BCX.

CRYSTALS, Brazilian Quartz. 1750 to 4000, Random frequencies 7/8 to 1", \$1.00. Within ten kilocycles, 1" \$1.50. To specified frequency X or Y, 1" \$3.50. 7000 to 7300, random frequencies, 7/8 to 1", \$3.50. Within fifteen kilocycles, \$7.50. Single signal crystals \$3.50, blanks \$1.50. Wm. Threm, W8FN, 4021 Davis Ave., Cheviot, Ohio.

TUBES as well as parts accepted for quality crystals, etc. Write needs, have bargains. W8DOQ, Route 1, Duluth, Minn.

TRADE Hoff 12 power binoculars for shortwave receiving equipment. Stier care Hotel Antlers, Indianapolis, Ind.

FREE crystals, insulators, sockets, chokes, engraved call plates, callbooks, with subscriptions. Sample copy and dope, 15¢; foreign, 20¢. "R/9", Box 666, Hollywood.

SELL — new SW-58 with or without National pack — make offer. W9ADS.

QSLs — 85¢. No stock forms. W8AKY.

QSLs. "Gil" Cartoon Service, West Hartford.

IN stock — Comet Pros, \$38; FB-7s, \$26.45, coils \$5.88; 866s, \$1.95; SW3s, \$14.40, band coils, \$2.69; Hammarlund, National, Thordarson, Weston-Jewell, Cardwell Bliley, Johnson parts. List, Henry's Radio Shop, Butler, Mo.

SELL, trade; RCA211, 204A, 851; WE212D, 276A; REL278 and 296 five meter receiver and transmitter; SW3; SW5; 1500V 450 watt MG; GR wavemeter, etc. W9ARA, Butler, Mo.

203As brand new, Westinghouse or GE, now \$10.00. Class B transformers, 210 — \$5.50; for 203As — \$3.50. Counterbalanced Cardwell 166Bs — \$20.00. 10,000V heavy duty 866s — \$2.50. New RCA UX250s — \$1.75. Weston type 301 milliammeters (some new, all new condition, most all ranges) \$3.75. 204As — \$20.00. 212Ds — \$18.00. Diaphragms installed in WE mikes \$5.00. Instructographs. List. Want 861s, 845s. Ewing, 1057 Pratt Blvd., Chicago.

MICROMETER condenser \$12.75. MFM complete, \$36. Ribbon microphone kit, \$5. Lampkin, W8ALK, Cincinnati.

FREQUENCY meters, lamp indicating type \$5. monitors \$7.75, dynatron frequency meters, \$10. All for 3500, 7000, 14000-kcs. bands. Complete satisfaction guaranteed. Andrews Radio Lab., 3520 Wisconsin St., Oakland, Calif.

TRANSMITTING and receiving equipment manufactured to order. Holmes C. Miller, Radio Engineer, Box 105, Palo Alto, California.

RELAY racks. Transmitters. See April display advertisement. Rectifier Engineering Service.

QSLs; 50 to 75 cents a hundred. W9GOF, Mishawaka, Ind.

CINO sockets fit all fifty watt tubes, \$1. each, postpaid. Cino Radio Shop, 1115 Murray Rd., Cincinnati, Ohio.

CRYSTALS — new price list ready. Dealers and clubs write for regular discounts. Bellefonte Radio Engineering Lab., Bellefonte, Penna.

.001 Dural for condenser mikes, 36 sq. in., 25¢. .0005 Dural for ribbon mikes, 36 sq. in., 50¢. Good tubes all kinds and sizes. Buy, sell, trade. W9ER, Timken, Kans.

WANTED: General Radio calibrated variable condenser type 222, 240 or similar. H. E. Wallace, R4, Burlington, N. C.

CONDENSERS — Not the ordinary kind but a limited quantity of brand new commercial type oil immersed power factor correction condensers, 8 Mfd. units conservatively rated at 1000 volts \$5.00 each or \$9.00 per pair. Have limited number of other sizes and ratings — write Ex-W4XC, 2710 Harvard Blvd., Dayton, Ohio.

FREE QSLs. W8BVE, Prospect Park, Franklin, Pa.

## GULF RADIO SCHOOL

Radiotelegraphy Radiotelephony

Radio Servicing

SECOND PORT } 844 Howard Avenue  
U. S. A. } NEW ORLEANS, LA.

## BLILEY CRYSTALS

POWERFUL ACCURATE UNIFORM

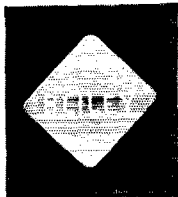

A scientifically manufactured crystal, powerful in output, accurate in frequency, and uniform in quality. 40, 80, 160M quartz x-cut crystals, supplied within 25Kc, \$4.50; 5Kc, \$5.50; 0.5Kc, \$6.50. 20M, 50Kc, \$12.75. Frequency tolerance — 0.05%. Calibration error considered zero.

BLILEY molded bakelite holders. For 20-40M, \$1.50; 80-160M, \$1.50. SS Filter, 465-525Kc, mounted, \$6.50.

Quartz crystals manufactured to your requirements from 20Kcs to 15Mc. Precision constant-temperature equipment. Write for folder Q250.

BLILEY PIEZO-ELECTRIC CO., ERIE, PA.

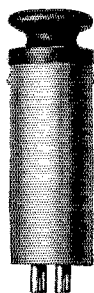

TYPE RE-39

Length Overall

5"

Winding Space

3 3/8"

Outside Diameter

1 1/2"

Base: Standard

4-5-6 prong

LIST PRICE

90c

## NEW! "MICALITE" LOW POWER FACTOR COIL FORM

A new Coil Form molded of "MICALITE" (bakelite and mica) possessing extremely low power factor at high frequencies. Can be drilled or machined as desired. Rich chrome yellow in color with handy knob for inserting and removing from socket; standard base to fit standard 4, 5 or 6 prong sockets; plenty of winding space for even 160 meter band. Watch for our complete line — Coming soon; Dealer's inquiries solicited. Write for new catalog.

Manufactured by

**THE BARRETT MFG. CO.**

1420 Kirkham Street

SAN FRANCISCO, CALIFORNIA

# Send

two 3c stamps  
for . . .

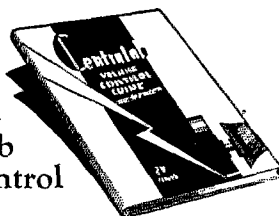

The  
New 50c  
Centralab  
Volume Control  
Guide

Thousands of these new Guides are now doing signal service . . . in helping servicemen to do a more efficient and satisfactory replacement job . . . with, of course, added profits. Send for the Centralab Guide on your stationery.

Address Dept. D

# Centralab

CENTRAL RADIO LABORATORIES

MILWAUKEE, WISCONSIN

# Your Nearest Dealer Is Your Best Friend

Your nearest dealer is entitled to your patronage. You can trust him. He is equipped with a knowledge and understanding of amateur radio. He is your logical and safe source of advice and counsel on what equipment you should buy. His stock is complete. He can supply your needs without delay. His prices are fair and consistent with the high quality of the goods he carries. He is responsible to you and interested in you.

Patronize the dealer nearest you—You can have confidence in him

|  |   |
|--|---|
| <p><b>CHICAGO, ILLINOIS</b><br/>Chicago Radio Apparatus Company<br/>415 South Dearborn Street<br/>Dependable Radio Equipment      Established 1921</p>       | <p><b>NEW ORLEANS, LOUISIANA</b><br/>Rose for Radio<br/>129 Camp Street<br/>Complete stock quality radio parts</p>  |
| <p><b>CHICAGO, ILLINOIS</b><br/>Mid-West Radio Mart<br/>520 S. State Street<br/>All standard lines carried in stock</p>                                      | <p><b>PHILADELPHIA, PENNSYLVANIA</b><br/>Eugene G. Wile<br/>10 S. Tenth Street<br/>Complete Stock of Quality Merchandise</p>  |
| <p><b>CLEVELAND, OHIO</b><br/>Northern Ohio Laboratories<br/>2073 West 85 Street<br/>W8BAH serving Cleveland and greater Cleveland Hams.</p>                 | <p><b>PORTLAND, OREGON</b><br/>Guy B. Paine Company<br/>391 Stark Street<br/>Transmitting and Receiving Parts</p>   |
| <p><b>CLEVELAND, OHIO</b><br/>Radio Servicemen's Supply Co.<br/>206 Prospect Street<br/>Wholesale Distributors catering to Amateurs, Dealers, Servicemen</p> | <p><b>PROVIDENCE, RHODE ISLAND</b><br/>W. H. Edwards &amp; Company<br/>32 Broadway, Room 23<br/>A full line of reliable Amateur Equipment &amp; Supplies</p>        |
| <p><b>DENVER, COLORADO</b><br/>Vreeland Radio Corporation<br/>1639 Tremont Street<br/>Amateur Radio Headquarters in the Rocky Mountain Region</p>            | <p><b>ST. LOUIS, MISSOURI</b><br/>Walter Ashe Radio Company<br/>1100 Pine Street<br/>W9FIS in charge of the oldest and largest parts store in St. Louis</p>         |
| <p><b>DETROIT, MICHIGAN</b><br/>Radio Specialties Company<br/>171 E. Jefferson Avenue<br/>Ham Supplies — National &amp; Hammarlund Sets and Parts</p>        | <p><b>ST. PAUL, MINNESOTA</b><br/><br/>Lew Bonn Company<br/>2484 University Avenue<br/>Rex L. Munger, W9LIP, Sales Engineer<br/>Complete Stock Radio Wholesaler</p> |
| <p><b>INDIANAPOLIS, INDIANA</b><br/>Kruse Radio, Inc.<br/>33 West Ohio Street<br/>Everything for the radio amateur and serviceman</p>                        | <p><b>SAN FRANCISCO, CALIFORNIA</b><br/>Offenbach Electric Company, Ltd.<br/>1452 Market Street<br/>"The House of a Million Radio Parts"</p>                        |
| <p><b>KANSAS CITY, MISSOURI</b><br/>Burstein-Applebee Company<br/>1012-14 McGee Street<br/>"Specialists" in supplies for the Amateur and Serviceman</p>      | <p><b>SCRANTON, PENNSYLVANIA</b><br/>Radio Service &amp; Supply Company<br/>608 Linden Street<br/>The only "Ham" Supply Store in N. E. Pennsylvania</p>             |
| <p><b>KANSAS CITY, MISSOURI</b><br/>Radio Laboratories<br/>1511 Walnut<br/>Amateur Headquarters — Complete Stock — Quality Parts</p>                         | <p><b>SPRINGFIELD, MASSACHUSETTS</b><br/>T. F. Cushing<br/>345 Worthington Street<br/>An amateur, endeavoring to sell good parts</p>                                |
| <p><b>MIAMI, FLORIDA</b><br/>Pan American Radio, Inc. formerly Fessenden-White<br/>1809 NE Second Avenue<br/>Everything in Radio</p>                         | <p><b>SYRACUSE, NEW YORK</b><br/>Roy C. Stage, W8IGF<br/>Complete stock of standard Ham &amp; BCL parts<br/>Standard Discounts. Free technical service by W8AOW</p> |
| <p><b>MILWAUKEE, WISCONSIN</b><br/>Radio Parts Company, Inc.<br/>332 West State Street<br/>Complete stock. Nationally Known products</p>                     | <p><b>UTICA, NEW YORK</b><br/>Vaeth Electric Company<br/>701 Verick Street<br/>Wholesale Distributors of Radio Parts and Supplies</p>                               |
| <p><b>NEWARK, NEW JERSEY</b><br/>Kaltman &amp; Romander<br/>62 Court Street<br/>Drop in for an over-counter QSO</p>  |   |

*This advertisement is paid for by the firms listed above. Qualified dealers are invited to apply for rates, etc., to Advertising Department, QST.*

Say You Saw It in QST — It Identifies You and Helps QST

# The League's Endorsement

¶ "Advertising for QST is accepted only from firms who, in the publisher's opinion, are of established integrity and whose products secure the approval of the technical staff of the American Radio Relay League."

Quoted from QST's advertising rate card.

For Your  
Own Protection,  
Buy Only  
From  
QST Advertisers

• See Editorial April issue of QST

## For Your Convenience QST'S INDEX OF ADVERTISERS IN THIS ISSUE

|   |                         |
|---|-------------------------|
| A.R.R.L. Application Blank .....          | 68                      |
| A.R.R.L. Booklet .....                    | 73                      |
| A.R.R.L. Examination Reprint .....        | 70                      |
| A.R.R.L. Handbook .....                   | <i>Cov. IV</i>          |
| A.R.R.L. Supplies .....                   | <i>Con. II</i>          |
| Barrett Mfg. Company .....                | 76                      |
| Blan, The Radio Man, Inc. ....            | 67                      |
| Bliley Piezo-Electric Co. ....            | 76                      |
| Candler System Company .....              | 74                      |
| Capitol Radio Engineering Institute ..... | 69                      |
| Cardwell Mfg. Corp., Allen D. ....        | 61                      |
| Central Radio Labs. ....                  | 76                      |
| Chicago Radio Apparatus Co. ....          | 67                      |
| Cornell Elec. Mfg. Company .....          | 69                      |
| Delta Mfg. Company .....                  | 69                      |
| Electrad, Inc. ....                       | 63                      |
| Federal Telegraph Company .....           | 80                      |
| General Radio Company .....               | 69                      |
| Gross Radio Company .....                 | 1                       |
| Gulf Radio School .....                   | 76                      |
| Hammarlund Mfg. Company .....             | 4                       |
| Hipower Crystal Co. ....                  | 63                      |
| Hygrade Sylvania Corp. ....               | 2                       |
| Kaltman & Romander .....                  | 72                      |
| Kenyon Transformer Co. ....               | 64                      |
| Leeds .....                               | 76                      |
| Littelfuse Laboratories .....             | 67                      |
| McGraw Hill Book Company .....            | 60                      |
| M. & H. Sporting Goods Co. ....           | 71                      |
| Mitchell, E. V. ....                      | 65                      |
| National Company .....                    | 59, 66, <i>Cov. III</i> |
| Port Arthur College .....                 | 71                      |
| Premier Crystal Labs. ....                | 65                      |
| QST Binder .....                          | 62                      |
| Radio Amateur Publishers .....            | 71                      |
| Radio Supply Company .....                | 67                      |
| Raytheon Production Corp. ....            | 65                      |
| Scientific Radio Service .....            | 67                      |
| Silver, Inc., McMurdo .....               | 63                      |
| Sound Engineering Corp. ....              | 71                      |
| Synthane Corp. ....                       | 74                      |
| Teleplex Company .....                    | 69                      |
| United Radio Mfg. Company .....           | 65                      |
| Universal Microphone Co. ....             | 73                      |
| Universal Wireless Sales Co. ....         | 74                      |
| West Side V. M. C. A. ....                | 73                      |





Ads appear like clockwork in QST.  
 Prompt service—plus bargain prices  
 like these—is the reason.

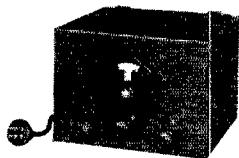

**NATIONAL SW 3**  
 The Popular SW 3 receivers now available in three models—with 2 volt, 2½ volt and 6 volt tubes. **\$14.42**

Prices reduced to.....  
 for the receiver and only **\$2.79** for each range of band-spread coils.

Kenyon uncased class "B" Transformers.

Minimum space requirements—light weight—good quality—lowest prices.

Class "B" input transformers for 46's—49's—53's—59's—79's—89's, each..... **\$1.43**

Output transformers to 4000 ohm R.F. load for these tubes, each..... **\$1.86**

Output transformers to voice coil..... **\$1.71**

**WESTERN ELECTRIC**

Signal Corps Type P-11 head phones; never sold below \$7.60 a pair. Now at a typical LEEDS bargain price, per pair, of only..... **\$3.95**

**Lechner Capacitors are ideal for bypass and blocking purposes**

Type A-1 8000 v. working 7.5 amp. at 1500 k.c.

1500 mmf } **Special**  
 2000 " } **\$3.32 net**  
 2500 " }

Type A-2 8000 v. working 7.5 amp. at 1500 k.c.

500 mmf } **\$2.63 net**  
 750 " }  
 1000 " }  
 1250 " }

Type A-3 5000 v. working .5 amp. at 60 mc.

75 mmf } **\$ .70 net**  
 100 " }  
 150 " }  
 200 " }  
 250 " }

**New Low Crystal Prices**

V cut crystals 160-80 M. bands .1 of 1% accuracy..... **\$3.50**  
 V cut 160-80 M. oscillator blanks..... **\$2.00**  
 X cut 80 M. .1 of 1% accuracy..... **\$4.75**  
 X cut 40 meter Crystals, random frequency, \$6.50  
 Leeds dustproof holder..... **\$1.45**  
 DeLux model..... **\$1.89**  
 General Radio crystal holder..... **\$2.25**

**No. 398 Gold Bug Automatic Transmitting Key**

**\$12.50** List. Simple in construction, correct mechanically, and electrically rugged and durable 3/32" contacts, complete with cord and plug. Brand new in original cartons. While they last, **\$4.45**

No. 10202 Extra heavy 3/16" contact..... **\$5.45**

**Navy Type Telegraph Key**

List **\$3.60** Navy knob—½" tungsten contacts. The balance..... **\$1.25**  
 with Regular Knob..... **\$1.10**

We do not publish a catalog. Lowest current prices, quoted by return mail on all short wave apparatus. Hundreds of other items at Big Special Prices.

**NATIONAL FB 7**

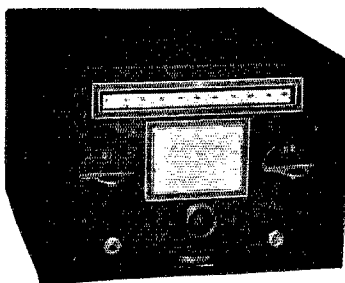

The Sensational FB 7 Superheterodyne at lowest wholesale prices.  
 FB 7 Receiver, stripped, less coils..... **\$26.46**  
 RBX Crystal filter model, less coils... **38.22**  
 All coil ranges, each pair..... **5.88**  
 5887 AB Power supply..... **14.42**  
 5897 AB Power supply..... **20.29**

Leeds 866 transformer—2½ v. 10 amp. Center tapped, 10,000 v. insulation. **\$2.75**  
 Leeds mounted fil. trans. 7½ v. 5 A.C.T. **\$2.95**  
 Leeds mounted 10 v. 7 amp. fil. trans. with 3 primary line taps to insure correct v. **\$3.95**  
 Leeds mounted fil. trans. 2½ v. 10 amp. 1000 v. insulation for receiver or 888 fil. in low voltage power supplies..... **\$1.15**  
 Leeds single button Mike trans..... **\$1.25**  
 Leeds double button Mike trans..... **\$1.45**  
 Leeds 2½ v. — 6 amp. trans..... **\$.95**  
 Leeds 2-2½ v. winding 5 amp.; can be used for 5 v. — 1000 v. insulation..... **\$1.45**

**General Radio Products**

Yes — we have a complete line in stock. Also some of those SPECIALS advertised last month are still available. Better order what you need now.

**We are prepared to sell**

fifteen factory wired "Supreme" single Signal supers, complete, at the kit price listed in our March advertisement. Fifteen hams are going to get a real bargain and we are going to get fifteen enthusiastic boosters.

**Flethheim High Voltage Filter Condensers at these low prices**

Type TC 1000 v. d.c. 750 v. r.a.c.  
 100 1. mfd. List \$3.00. Spec..... **\$1.50**  
 200 2. mfd. List \$5.00. Spec..... **2.50**  
 400 4. mfd. List \$9.00. Spec..... **4.50**  
 Type T 1500 v. d.c. 100 v. r.a.c.  
 100 1. mfd. List \$3.75. Spec..... **\$1.88**  
 200 2. mfd. List \$6.50. Spec..... **3.25**  
 400 4. mfd. List \$11.00. Spec..... **5.50**  
 Type TH 2000 v. d.c. 1600 v. r.a.c.  
 100 1. mfd. List \$7.00. Spec..... **\$3.50**  
 200 2. mfd. List \$12.50. Spec..... **6.25**  
 400 4. mfd. List \$22.00. Spec..... **11.00**  
 Type HP 3000 v. d.c. 2200 v. r.a.c.  
 100 1. mfd. List \$15.00. Spec..... **\$7.50**  
 200 2. mfd. List \$25.00. Spec..... **12.50**  
 400 4. mfd. List \$48.00. Spec..... **24.00**

**Hammarlund Midget Condensers with Isolantite insulation**

MC 20..... **\$.86** MC 100..... **\$1.26**  
 MC 35..... **.86** MC 140..... **1.43**  
 MC 50..... **1.03** MCD 140 dual..... **2.74**  
 MC 75..... **1.14** MC-35x split stator double spaced..... **2.51**

**Aerovox Fixed Condensers at lowest prices**

No. 1460 midget type in moulded bakelite  
 40 mmf to 250 mmf..... **\$.12**  
 500 mmf..... **.14**  
 1000 mmf..... **.14**  
 2000 mmf..... **.20**  
 2500 mmf..... **.23**  
 4000 mmf..... **.30**

**Genuine Type C Baldwin Phones**

**\$12.00** List—Mica diaphragm. Limited quantity—only 2 pair to a customer. Special..... **\$7.75**  
 Imported 400 ohm featherweight phones. Special..... **\$1.35**  
 Acme 2000 ohm featherweight phones..... **\$1.15**  
 Acme 4000 ohm featherweight phones..... **\$1.45**  
 Kellogg and Amplion Single-Button Microphones. Ideal for portable transmitter. Extra Special..... **\$1.75**

**Weston 566 Set Analyzers**

Brand new, original cartons, up to the minute factory guarantee. Complete with 6 and 7 prong adapters. Now you can secure these analyzers at better than the distributor's price, only..... **\$55.95**

A few of the tube checkers and oscillators advertised last month are still available at seasonally low prices; listed in Feb. QST. Descriptive bulletins on request.



45 Vesey Street, New York City  
 New York Headquarters for Transmitting Apparatus

Say You Saw It in QST — It Identifies You and Helps QST

MAIL ORDERS FILLED SAME DAY

C. O. D. Orders Must Be Accompanied by 10% Deposit

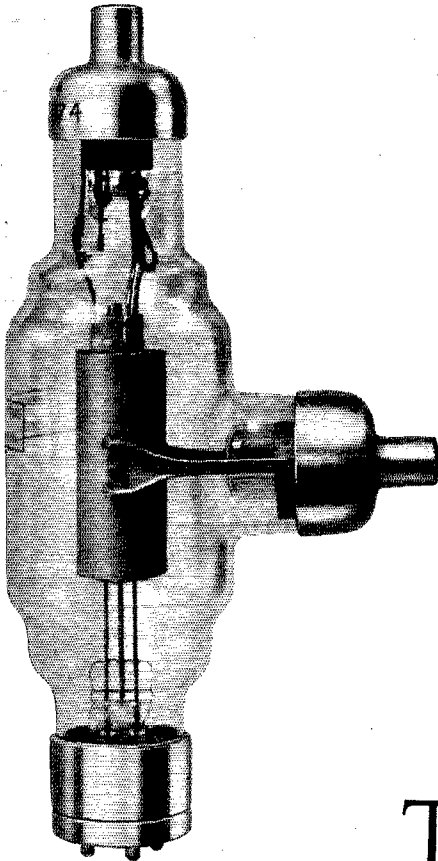

# Federal Tubes Available for Amateur Use

THE F-108-A, a member of the Federal family of high-power transmitting and rectifier tubes, is particularly suitable for amateur use. Extremely low interelectrode capacity, small internal inductance and high interelectrode insulation make it a highly satisfactory oscillator or amplifier for frequencies up to 120 megacycles. Designed, as are all Federal tubes, for the exacting requirements of commercial service, it is rugged, efficient and manufactured to rigid standards.

### Characteristics of the F-108-A

- Filament potential.....10 volts
- Filament current.....11 amps.
- Average characteristics with plate potential of 1500 volts and zero grid potential:
- Average plate current.....0.130 amps.
- Average plate resistance.....8500 ohms
- Average amplification factor.....12
- Mutual conductance.....1400  $\mu$ mhos
- Approximate direct interelectrode capacities:
- Plate to grid.....7  $\mu$ mf.
- Plate to filament.....2  $\mu$ mf.
- Grid to filament.....3  $\mu$ mf.
- Maximum operating plate potential 3000 volts
- Maximum plate current.....0.200 amps.
- Maximum continuous plate dissipation.....175 watts
- Maximum overall length.....11 inches
- Maximum width.....7 inches

Net Price \$34.50

SEND FOR BULLETIN

## FEDERAL TELEGRAPH COMPANY

200 Mt. Pleasant Avenue, Newark, N. J.

# FOR · THAT · SINGLE-SIGNAL · RECEIVER

The NATIONAL Air Dielectric Tuned I. F. Transformer described in the 10th Edition of the A.R.R.L. Handbook has been completely redesigned.

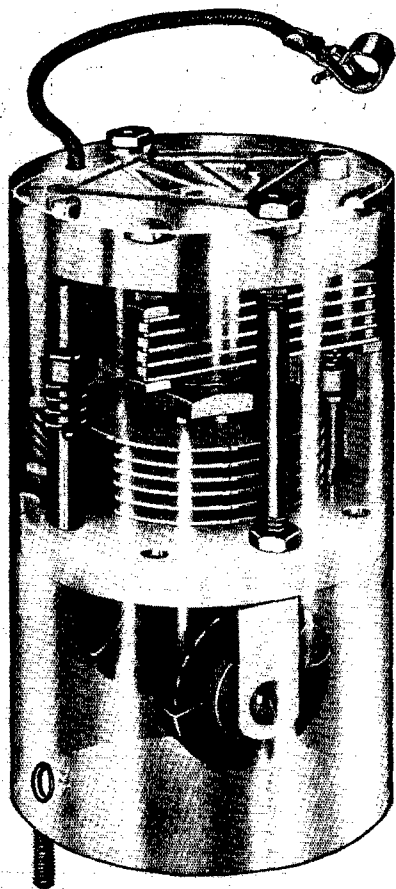

Actual Size. U. S. Patents Nos. 1,656,532, 1,713,146.  
Others pending.

For replacement or  
set construction

List price **\$5.00**  
(Less usual trade discount)

- Micrometer Tuning — Velvet Vernier Type
- All Peaking Adjustments at Top of Shield
- Double Bearing Precision Condensers
- Self Locking Rotors
- Isolantite Insulation
- Adjustable Coupling
- New Type of Litz Wound Coils
- 450 to 550 KC Tuning Range
- Non-resonant Aluminum Rotor and Stator Plates
- Electron Coupled Beat Frequency Oscillator Units with Genuine Velvet Vernier Knob Tuning
- Standard Mounting

Standard Equipment on the Single-Signal AGS and available for the Standard AGS, the FB-7, and the FB-X; it is completely interchangeable with the standard unit and may be substituted at any time.

**NATIONAL COMPANY, INC., MALDEN, MASS.**



**Once upon a**

**time there were**

**no guideposts in ama-**

**teur radio. The sum total**

**of all human knowledge of the**

**subject was negligible. Then ama-**

**teurs began discovering things. Principles and**

**practices were established. Knowledge of the progress**

**of development became available in printed form through QST. At last**

**came The Radio Amateur's Handbook. Today it represents a careful sifting of all the**

**world's accumulated knowledge of amateur radio. It is the fundamentally important book**

**to every radio amateur. The 200 pages of the new 10th Edition contain all the guideposts to modern ama-**

**teur radio. The price is \$1 (in sturdy cloth binding, \$2), postpaid anywhere. The American Radio Relay League, West Hartford, Conn.**